

EH7L4CN
EH7L4SW
EH7L4WE



DE	Backofen	Benutzerinformation	2
FR	Four	Notice d'utilisation	38
IT	Forno	Istruzioni per l'uso	73
EN	Oven	User Manual	108

WIR DENKEN AN SIE

Danke, dass Sie ein Gerät von Electrolux gekauft haben. Sie haben sich für ein Produkt entschieden, in dem jahrzehntelange Berufserfahrung und Innovation stecken. Bei der Entwicklung dieses genialen und eleganten Geräts haben wir an Sie gedacht. Wann immer Sie das Gerät verwenden, können Sie sicher sein, dass Sie jedes Mal großartige Ergebnisse erzielen.

Willkommen bei Electrolux.

Besuchen Sie unsere Website, um:



Anwendungshinweise, Prospekte, Informationen zu Fehlerbehebung, Service und Reparatur zu erhalten:

www.electrolux.com/support

Ihr Produkt für einen besseren Service zu registrieren:

www.registerelectrolux.com



Zubehör, Verbrauchsmaterial und Original-Ersatzteile für Ihr Gerät zu kaufen:

www.electrolux.com/shop



Weitere Rezepte, Tipps und Downloads für die Fehlerbehebung in der App **My Electrolux Kitchen**.





KUNDENDIENST UND SERVICE

Verwenden Sie ausschließlich Original-Ersatzteile.

Halten Sie folgende Angaben bereit, wenn Sie sich an unseren autorisierten Kundendienst wenden: Modell, PNC, Seriennummer.

Die Daten finden Sie auf dem Typenschild.

-  Warnungs-/Sicherheitshinweise
-  Allgemeine Informationen und Empfehlungen
-  Informationen zum Umweltschutz

Änderungen vorbehalten.

INHALTSVERZEICHNIS

1. SICHERHEITSHINWEISE	3	2.7 Entsorgung	9
1.1 Sicherheit von Kindern und schutzbedürftigen Personen.....	3	3. GERÄTEBESCHREIBUNG	10
1.2 Allgemeine Sicherheitshinweise.....	4	3.1 Gesamtansicht.....	10
2. SICHERHEITSANWEISUNGEN	6	3.2 Zubehörteile.....	10
2.1 Aufstellen.....	6	4. BEDIENFELD	11
2.2 Elektroanschluss.....	7	4.1 Versenkbare Knöpfe.....	11
2.3 Bedienung.....	7	4.2 Einstellknöpfe für die Garzonen.....	11
2.4 Reinigung und Pflege.....	8	4.3 Garstufen.....	11
2.5 Innenbeleuchtung.....	8	4.4 Verwenden der Zweikreiszone (falls vorhanden).....	11
2.6 Wartung.....	9	4.5 Sensorfelder im Bedienfeld.....	12

5. VOR DEM ERSTEN GEBRAUCH.....	12	10.2 Feuchte Umluft - empfohlenes Zubehör.....	26
5.1 Erste Reinigung.....	13	10.3 Gartabellen für Prüfinstitute.....	26
5.2 Erstes Vorheizen.....	13		
6. TÄGLICHER GEBRAUCH.....	13	11. REINIGUNG UND PFLEGE.....	28
6.1 Einstellung: Ofenfunktionen.....	13	11.1 Hinweise zur Reinigung.....	29
6.2 Ofenfunktionen.....	14	11.2 Entfernen der: Einhängegitter	29
6.3 Hinweise für: Feuchte Umluft.....	15	11.3 Entfernen: Grill.....	30
6.4 Einstellung: VarioGuide.....	15	11.4 Aus- und Einbau: Tür.....	30
6.5 VarioGuide.....	16	11.5 Wie ersetzt man: Lampe.....	32
7. UHRFUNKTIONEN.....	21	12. FEHLERSUCHE.....	32
7.1 Uhrfunktionen.....	21	12.1 Was tun, wenn	32
7.2 Einstellung: Uhrfunktionen.....	22	12.2 Servicedaten.....	33
8. VERWENDUNG: ZUBEHÖRTEILE.....	23	13. ENERGIEEFFIZIENZ.....	34
8.1 Einsetzen der Zubehörteile.....	23	13.1 Produktinformationen und Produktinformationsblatt.....	34
9. ZUSATZFUNKTIONEN.....	24	13.2 Energie sparen.....	35
9.1 Verriegelung.....	24	14. MENÜSTRUKTUR.....	35
9.2 Abschaltautomatik.....	24	14.1 Menü.....	35
9.3 Kühlgebläse.....	25	15. GARANTIE.....	36
10. RATSCHLÄGE UND TIPPS.....	25	16. UMWELTTIPPS.....	37
10.1 Feuchte Umluft.....	25		

1. SICHERHEITSHINWEISE

Lesen Sie vor der Installation und Verwendung des Gerätes die mitgelieferte Anleitung sorgfältig durch. Der Hersteller ist nicht verantwortlich für Verletzungen oder Schäden, die durch unsachgemäße Installation oder Verwendung entstehen. Bewahren Sie die Anweisungen immer an einem sicheren und zugänglichen Ort auf, um sie später wiederverwenden zu können.

1.1 Sicherheit von Kindern und schutzbedürftigen Personen

- Das Gerät kann von Kindern ab 8 Jahren und Personen mit eingeschränkten physischen, sensorischen oder geistigen Fähigkeiten oder mit mangelnder Erfahrung und/oder mangelndem Wissen nur dann verwendet werden, wenn sie durch eine für ihre Sicherheit zuständige Person

beaufsichtigt werden oder in die sichere Verwendung des Geräts eingewiesen wurden und die mit dem Gerät verbundenen Gefahren verstanden haben. Kinder unter 8 Jahren sowie Personen mit schweren Behinderungen oder Mehrfachbehinderung sollten vom Gerät ferngehalten werden, wenn sie nicht ständig beaufsichtigt werden.

- Kinder müssen beaufsichtigt werden, und es ist sicher zu stellen, dass sie nicht mit dem Gerät spielen.
- Halten Sie sämtliches Verpackungsmaterial von Kindern fern, und entsorgen Sie es angemessen.
- **WARNUNG:** Das Gerät und zugängliche Teile werden während des Betriebs heiss. Halten Sie Kinder und Haustiere vom Gerät fern, wenn es in Betrieb ist oder abkühlt.
- Falls Ihr Gerät mit einer Kindersicherung ausgestattet ist, sollte diese aktiviert werden.
- Wartung oder Reinigung des Geräts darf nicht von Kindern ohne Aufsicht erfolgen.

1.2 Allgemeine Sicherheitshinweise

- Dieses Gerät ist nur zum Kochen bestimmt.
- Dieses Gerät ist für den Gebrauch in einem einzelnen Haushalt in Innenräumen konzipiert.
- Dieses Gerät kann in Büros, Hotelzimmern, Bed & Breakfast-Gästezimmern, Bauernhöfen und anderen ähnlichen Unterkünften verwendet werden, wenn das Niveau des (durchschnittlichen) Haushaltsverbrauchs nicht überschritten wird.
- Die Installation des Geräts und der Austausch des Kabels muss von einer Fachkraft vorgenommen werden.
- Verwenden Sie das Gerät nicht, bevor Sie es in die Einbaustruktur eingebaut haben.
- Trennen Sie das Gerät von der Stromversorgung, bevor Sie Wartungsarbeiten vornehmen.

- Wenn das Netzkabel beschädigt ist, muss es vom Hersteller, seinem autorisierten Kundenservice oder einer gleichermassen qualifizierten Person ausgetauscht werden, um Gefährdungen durch elektrischen Strom zu vermeiden.
- Um mögliche Gefahren zu vermeiden, muss das Bedienfeld mit den passenden farblich gekennzeichneten Steckverbindern am vorgeschriebenen Heizelement angeschlossen werden.
- Die Mittel zum Trennen des Stromanschlusses müssen gemäss den Verdrahtungsvorschriften in die feste Verdrahtung integriert sein.
- **WARNUNG:** Stellen Sie sicher, dass das Gerät abgeschaltet ist, bevor Sie das Leuchtmittel ersetzen, um die Gefahr eines elektrischen Stromschlags zu vermeiden.
- **WARNUNG:** Das Gerät und zugängliche Teile werden während des Betriebs heiss. Achten Sie darauf, die Heizelemente und die Oberflächen im Backofen nicht zu berühren.
- Verwenden Sie immer Topfhandschuhe, wenn Sie Zubehör oder Backofengeschirr in den Backofen stellen oder herausnehmen.
- Zum Entfernen der Schienen ziehen Sie zunächst das vordere Teil und dann das hintere Ende der Schienen weg von den Seitenwänden. Führen Sie zum Einsetzen der Einhängegitter die obigen Schritte in umgekehrter Reihenfolge aus.
- Reinigen Sie das Gerät nicht mit einem Dampfreiniger.
- Benutzen Sie zum Reinigen der Glasabdeckung des Herdes keine scharfen Scheuermittel oder Metallschwämmchen – sie könnten die Glasfläche verkratzen und zum Zersplittern der Scheibe führen.

2. SICHERHEITSAUWEISUNGEN

2.1 Aufstellen

**WARNUNG!**

Das Gerat darf nur von einer Fachkraft installiert werden.

- Entfernen Sie die gesamte Verpackung.
- Montieren oder verwenden Sie ein beschadigtes Gerat nicht.
- Halten Sie sich an die mitgelieferte Montageanleitung.
- Seien Sie beim Bewegen des Gerates vorsichtig, da es sehr schwer ist. Tragen Sie stets Sicherheitshandschuhe und festes Schuhwerk.
- Ziehen Sie das Gerat nicht am Turgriff.
- Installieren Sie das Gerat an einem sicheren, geeigneten Aufstellort, der die Installationsanforderungen erfullt.
- Das Kuchenschrankmobel und die Einbaunische mussen die passenden Abmessungen aufweisen.
- Die Mindestabstande zu anderen Geraten und Kuchenschrankmobeln sind einzuhalten.
- Prufen Sie vor Montage des Gerates, dass sich die Ofentur unbehindert offnen lasst.
- Einige Teile des Gerates sind stromfuhrend. Das Kuchenschrankmobel muss auf allen Seiten mit dem Gerat abschliessen, um einen Kontakt mit stromfuhrenden Teilen zu vermeiden.
- Das Gerat ist mit einem elektrischen Kuhlsystem ausgestattet. Es muss mit der Stromversorgung betrieben werden.
- Das Einbaugerat muss die Bestandigkeitsanforderungen nach DIN 68930 erfullen.

Mindesthohe des Schrankes (Mindesthohe des Schrankes unter Arbeitsplatte)	762 (762) mm
Breite des Schrankes	550 mm
Tiefe des Schrankes	605 (580) mm
Hohe der Vorderseite des Gerates	757 mm
Hohe der Ruckseite des Gerates	739 mm
Breite der Vorderseite des Gerates	549 mm
Breite der Ruckseite des Gerates	548 mm
Tiefe des Gerates	567 mm
Einbautiefe des Gerates	546 mm
Tiefe bei geoffneter Tur	1017 mm
Mindestgroe der Luftungsoffnung. offnung unten auf der Ruckseite	550 x 20 mm

Befestigungsschrauben	4x12 mm
-----------------------	---------

2.2 Elektroanschluss



WARNUNG!

Brand- und Stromschlaggefahr.

- Alle elektrischen Anschlüsse sind von einem geprüften Elektriker vorzunehmen.
- Das Gerät muss geerdet sein.
- Achten Sie darauf, dass die Parameter auf dem Typenschild mit den elektrischen Werten der Netzstromversorgung übereinstimmen.
- Schliessen Sie das Gerät unbedingt an eine sachgemäss installierte Schutzkontaktsteckdose an.
- Verwenden Sie keine Mehrfachsteckdosen oder Verlängerungskabel.
- Achten Sie darauf, Netzstecker und Netzkabel nicht zu beschädigen. Falls das Netzkabel des Geräts ersetzt werden muss, lassen Sie diese Arbeit durch unseren autorisierten Kundendienst durchführen.
- Achten Sie darauf, dass das Netzkabel die Gerätetür nicht berührt oder in ihre Nähe gelangt, insbesondere wenn die Tür heiss ist.
- Alle Teile zum Schutz vor direktem Berühren sowie die isolierten Teile müssen so befestigt werden, dass sie nicht ohne Werkzeug entfernt werden können.
- Stecken Sie den Netzstecker erst am Ende der Installation in die Steckdose. Stellen Sie sicher, dass der Netzstecker nach der Montage noch zugänglich ist.
- Falls die Steckdose lose ist, schliessen Sie den Netzstecker nicht an.
- Ziehen Sie nicht am Netzkabel, wenn Sie das Gerät von der Stromversorgung trennen möchten. Ziehen Sie stets am Netzstecker.
- Verwenden Sie nur geeignete Trenneinrichtungen: Überlastschalter, Sicherungen (Schraubsicherungen müssen aus dem Halter entfernt werden können), Fehlerstromschutzschalter und Schütze.
- Die elektrische Installation muss eine Trenneinrichtung aufweisen, mit der das Gerät allpolig von der Spannungsversorgung getrennt werden kann. Die Trenneinrichtung muss mit einer Kontaktöffnungsbreite von mindestens 3 mm ausgeführt sein.
- Dieses Gerät wird ohne Netzstecker oder Netzkabel geliefert.

2.3 Bedienung



WARNUNG!

Verletzungs-, Verbrennungs- und Stromschlaggefahr oder Explosionsgefahr.

- Nehmen Sie keine technischen Änderungen am Gerät vor.
- Stellen Sie sicher, dass die Lüftungsöffnungen nicht blockiert sind.
- Lassen Sie das Gerät bei Betrieb nicht unbeaufsichtigt.
- Schalten Sie das Gerät nach jedem Gebrauch ab.
- Gehen Sie beim Öffnen der Tür vorsichtig vor, wenn das Gerät in Betrieb ist. Heisse Luft kann entweichen.
- Bedienen Sie das Gerät nicht mit nassen Händen oder wenn es mit Wasser in Kontakt gekommen ist.
- Üben sie keinen Druck auf die offene Tür aus.
- Benutzen Sie das Gerät nicht als Arbeits- oder Abstellfläche.

SICHERHEITSANWEISUNGEN

- Öffnen Sie die Gerätetür vorsichtig. Die Verwendung von Zutaten, die Alkohol enthalten, kann eine Mischung aus Alkohol und Luft zur Folge haben.
- Achten Sie beim Öffnen der Tür darauf, dass keine Funken oder offene Flammen in das Gerät gelangen.
- Bringen Sie keine entflammaren Produkte oder nasse Gegenstände mit entflammaren Produkten in das Gerät, in die Nähe des Geräts oder auf das Gerät.



WARNUNG!

Risiko von Schäden am Gerät.

- Um Beschädigungen oder Verfärbungen der Emaillebeschichtung zu vermeiden:
 - Stellen Sie feuerfestes Geschirr oder andere Gegenstände nicht direkt auf den Boden des Geräts.
 - Legen Sie keine Aluminiumfolie direkt auf den Garraumboden des Geräts.
 - Füllen Sie kein Wasser in das heisse Gerät.
 - Bewahren Sie kein feuchtes Geschirr oder Lebensmittel im Gerät auf, wenn Sie den Garvorgang beendet haben.
 - Gehen Sie beim Herausnehmen oder Einsetzen des Zubehörs sorgfältig vor.
- Verfärbungen der Emaille- oder Edelstahlbeschichtung haben keine Auswirkung auf die Leistung des Geräts.
- Verwenden Sie für nasse Kuchen eine tiefes Blech. Fruchtsäfte verursachen Flecken, die möglicherweise permanent sind.
- Garen Sie immer bei geschlossener Backofentür.

2.4 Reinigung und Pflege



WARNUNG!

Verletzungs-, Brandgefahr sowie Risiko von Schäden am Gerät.

- Schalten Sie vor Wartungsarbeiten immer das Gerät aus und ziehen Sie den Netzstecker aus der Steckdose.
- Vergewissern Sie sich, dass das Gerät abgekühlt ist. Es besteht die Gefahr, dass die Glasscheiben brechen.
- Ersetzen Sie die Türglasscheiben umgehend, wenn sie beschädigt sind. Wenden Sie sich an den autorisierten Kundendienst.
- Gehen Sie beim Aushängen der Tür sorgsam vor. Die Tür ist schwer!
- Reinigen Sie das Gerät regelmässig, um eine Abnutzung des Oberflächenmaterials zu verhindern.
- Reinigen Sie das Gerät mit einem weichen, feuchten Tuch. Verwenden Sie ausschliesslich Neutralreiniger. Benutzen Sie keine Scheuermittel, scheuernde Reinigungsschwämmchen, Lösungsmittel oder Metallgegenstände.
- Falls Sie ein Ofenspray verwenden, befolgen Sie die Sicherheitsanweisungen auf seiner Verpackung.

2.5 Innenbeleuchtung



WARNUNG!

Stromschlaggefahr.

- Bezüglich der Lampen in diesem Produkt und der separat erhältlichen Ersatzlampen: Diese Lampen dienen dazu, extremen Bedingungen in Haushaltsgeräten zu widerstehen, z. B. Temperatur, Vibration, Feuchtigkeit, oder Informationen zum Betriebsstatus des Geräts

anzuzeigen. Sie dienen nicht dem Einsatz in anderen Anwendungen und eignen sich nicht zur Raumbeleuchtung.

- Dieses Produkt enthält eine Lichtquelle der Energieeffizienzklasse G.
- Verwenden Sie stets nur eine Lampe mit der gleichen Leistung..

2.6 Wartung

- Zur Reparatur des Geräts wenden Sie sich an einen autorisierten Kundendienst.
- Verwenden Sie ausschließlich Original-Ersatzteile.

2.7 Entsorgung



WARNUNG!

Verletzungs- oder Erstickungsgefahr.

- Kontaktieren Sie die Behörden vor Ort, um Informationen darüber zu erhalten, wie Sie das Gerät entsorgen können.
- Trennen Sie das Gerät von der Spannungsversorgung.
- Schneiden Sie das Netzkabel in der Nähe des Geräteanschlusses ab, und entsorgen Sie es.
- Entfernen Sie das Türschloss, um zu verhindern, dass sich Kinder oder Haustiere im Gerät einschliessen.

3. GERÄTEBESCHREIBUNG

3.1 Gesamtansicht

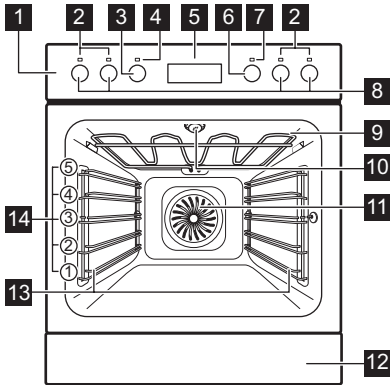

- 1** Bedienfeld
- 2** Lampen/-symbole der Kochzonen
- 3** Einstellknopf für Ofenfunktionen
- 4** Betriebskontrolllampe/-symbol
- 5** Display
- 6** Einstellknopf
- 7** Temperaturanzeige/-symbol
- 8** Einstellknöpfe für die Garzonen
- 9** Heizelement
- 10** Lampe
- 11** Umluft
- 12** Schublade
- 13** Einhängegitter, herausnehmbar
- 14** Einschubebene

3.2 Zubehörteile

Gitterrost

Für Töpfe, Backformen, Roste.

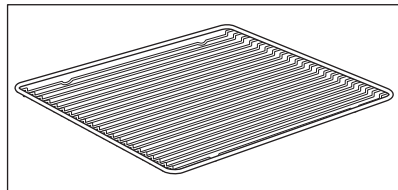

Backblech

Für Kuchen und Biskuitboden.

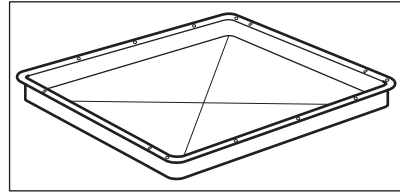

4. BEDIENFELD

4.1 Versenkbare Knöpfe

Drücken Sie zum Benutzen des Geräts den Knopf. Der Knopf springt heraus.

4.2 Einstellknöpfe für die Garzonen





WARNUNG!

Siehe Kapitel «Sicherheit» in der Bedienungsanleitung des Kochfelds.

Sie können das Kochfeld mit den Drehknöpfen für die Kochzonen bedienen.

4.3 Garstufen

Knopfanzeige	Funktion
0	Aus-Position
	Einstellung Warmhalten
1 - 9	Garstufen
	Doppelzonenschalter

Drehen Sie den Knopf und stellen Sie eine Kochstufe ein.

4.4 Verwenden der Zweikreiszone (falls vorhanden)









Drehen Sie den Knopf im Uhrzeigersinn, um die Zweikreiszone einzuschalten. Drehen Sie ihn jedoch nicht über die Endposition hinaus.







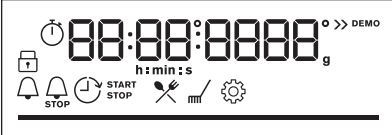

1. Drehen Sie den Knopf im Uhrzeigersinn auf die Position 9.
2. Drehen Sie den Knopf langsam auf das Symbol , bis er hörbar einrastet. Die beiden Kreise der Kochzone sind eingeschaltet.
3. Zum Einstellen der gewünschten Kochstufe siehe „Kochstufen“.

VOR DEM ERSTEN GEBRAUCH

4.5 Sensorfelder im Bedienfeld

				OK		
Kurzzeitwecker	Schnellaufheizung	Backofenbeleuchtung	Verriegelung	Einstellung bestätigen	Drücken Sie	Drehen Sie den Knopf
Wählen Sie eine Ofenfunktionen aus und schalten Sie den Backofen ein.						
Drehen Sie den Backofen-Einstellknopf in die Position Aus, um den Ofen auszuschalten.						

	Display mit wichtigen Funktionen.
---	-----------------------------------

Display/Anzeigen:	 Verriegelung	 VarioGuide	 Einstellungen	 Schnellaufheizung
Kurzzeitweckeranzeigen:				
Fortschrittsanzeige —für Temperatur oder Zeit. Die Anzeige wird vollständig rot, wenn der Ofen die eingestellte Temperatur erreicht hat.				

5. VOR DEM ERSTEN GEBRAUCH

 WARNUNG! Siehe Kapitel „Sicherheitshinweise“.
--

5.1 Erste Reinigung

Vor der ersten Anwendung reinigen Sie den leeren Ofen und stellen die Zeit ein:			
			 00:00 Stellen Sie die Zeit ein. Drücken Sie OK.

5.2 Erstes Vorheizen

Heizen Sie den leeren Ofen vor der ersten Inbetriebnahme auf.	
Schritt 1	Entfernen Sie das gesamte Zubehör und die herausnehmbaren Einhängegitter aus dem Ofen.
Schritt 2	Stellen Sie die Höchsttemperatur für die Funktion ein: Lassen Sie den Ofen 1 Stunde eingeschaltet.
Schritt 3	Stellen Sie die Höchsttemperatur für die Funktion ein: Lassen Sie den Ofen 15 min eingeschaltet.
ⓘ Beim Vorheizen kann das Gerät Geruch und Rauch verströmen. Achten Sie darauf, dass der Raum gut belüftet ist.	

6. TÄGLICHER GEBRAUCH

	WARNUNG! Siehe Kapitel „Sicherheitshinweise“.
--	---







6.1 Einstellung: Ofenfunktionen



Schritt 1	Schritt 2

Wählen Sie eine Ofenfunktion aus.	Stellen Sie die Temperatur ein. Drücken Sie OK .
 - drücken und halten, um die Funktion einzuschalten: Schnellaufheizung. Dies ist für einige Ofenfunktionen verfügbar.	

6.2 Ofenfunktionen

Standard-Ofenfunktionen

Ofenfunktion	Anwendung
 Heissluft	Zum Backen und Braten auf drei Einschubebenen und zum Dörren von Lebensmitteln. Stellen Sie eine 20–40 °C niedrigere Temperatur ein als bei Ober-/Unterhitze.
 Ober-/Unterhitze	Zum Backen und Braten auf einer Ebene.
 Tiefkühlgerichte	Damit Fertiggerichte (z. B. Pommes Frites, Kartoffelwedges und Frühlingsrollen) schön knusprig werden.
 Pizzastufe	Zubereiten von Pizza. Für intensives Bräunen und einen knusprigen Boden.
 Unterhitze	Kuchen mit knusprigen Böden backen und Lebensmittel konservieren.
 Auftauen	Auftauen von Speisen (Gemüse und Früchte). Die Auftauzeit hängt von der Menge und der Grösse der Tiefkühlgerichte ab.
 Feuchte Umluft	Diese Funktion dient dem Energiesparen beim Kochen. Bei Verwendung dieser Funktion kann die Temperatur im Garraum von der eingestellten Temperatur abweichen. Die Restwärme wird genutzt. Die Heizleistung kann reduziert werden. Weitere Informationen finden Sie im Kapitel «Täglicher Gebrauch», Hinweise zu: Feuchte Umluft.

Ofenfunktion	Anwendung
 Grill	Zum Grillieren von dünnen Speisen und zum Toasten von Brot.
 Heissluftgrillen	Zum Braten grosser Fleischstücke oder von Geflügel mit Knochen auf einer Einschubebene. Zum Gratinieren und Bräunen.
 Menü	Zur Menüeingabe: VarioGuide, Reinigung, Einstellungen.

6.3 Hinweise für: Feuchte Umluft

Diese Funktion wurde verwendet, um der Energieeffizienzklasse und den Ökodesign-Anforderungen gemäss EU 65/2014 und EU 66/2014 zu entsprechen. Prüfungen nach: IEC/EN 60350-1

Die Ofentür muss beim Garen geschlossen werden, damit die Funktion nicht unterbrochen wird und der Ofen möglichst energiesparend funktioniert.







Wenn Sie diese Funktion verwenden, schaltet sich die Ofenbeleuchtung nach 30 s automatisch aus.

Anweisungen zum Garen finden Sie im Kapitel «Hinweise und Tipps», Feuchte Umluft. Allgemeine Hinweise zum Energiesparen finden Sie im Kapitel «Energie-Effizienz», Energiesparen.

6.4 Einstellung: VarioGuide

Für jedes Gericht in diesem Untermenü wird eine Funktion und Temperatur empfohlen. Sie können die Zeit und Temperatur während des Garens einstellen.

Einige der Gerichte können Sie auch mit folgender Funktion zubereiten:	<ul style="list-style-type: none"> • Gewichtsautomatik
--	---



VarioGuide - kann zur schnellen Zubereitung einer Speise mit voreingestellten Funktionen verwendet werden:			
Schritt 1	Schritt 2	Schritt 3	Schritt 4
 	 	 P1 - P45	 OK

TÄGLICHER GEBRAUCH





VarioGuide - kann zur schnellen Zubereitung einer Speise mit voreingestellten Funktionen verwendet werden:





Rufen Sie das Menü auf.	Wählen Sie VarioGuide. Drücken Sie OK.	Wählen Sie die Speise aus. Drücken Sie OK.	Stellen Sie die Speise in den Backofen. Bestätigen Sie die Einstellung.
-------------------------	--	--	---

6.5 VarioGuide













Legende	
	Gewichtsautomatik verfügbar.
	Heizen Sie den Backofen vor dem Garen vor.
	Einschubebene.

















Wenn die Funktion endet, überprüfen Sie, ob die Speise fertig gegart ist.

	Speise	Gewicht	Einschubebene/Zubehör	Garzeit
Rind 				
P1	Roastbeef, blutig	1–1,5 kg; 4–5 cm dicke Stücke	 2; Backblech Braten Sie das Fleisch einige Min.uten in einer heißen Pfanne an. Geben Sie es in den Ofen.	40 Min.
P2	Roastbeef, medium			50 Min.
P3	Roastbeef, durch			60 Min.
P4	Steak, medium	180–220 g pro Stück, 3 cm dicke Scheiben	  3; Braten der Speise auf dem Gitterrost Braten Sie das Fleisch einige Min.uten in einer heißen Pfanne an. Geben Sie es in den Ofen.	15 Min.





















	Speise	Gewicht	Einschubebene/Zubehör	Garzeit
P5	Rinderbraten/ Schmorbraten (Hochrippe, Oberschale, dicke Spannrippe)	1,5–2 kg	 2 ; Braten der Speise auf dem Git-terrost Braten Sie das Fleisch einige Min.uten in einer heissen Pfanne an. Fügen Sie Flüssigkeit hinzu. Geben Sie es in den Ofen.	120 Min.
P6	Roastbeef, blutig (Niedertemperatur Garen)	1–1,5 kg; 4– 5 cm dicke Stücke	 2 ; Backblech Verwenden Sie Ihre liebsten Gewürze oder einfach nur Salz und frisch gemahlene(n) Pfeffer. Braten Sie das Fleisch einige Min.uten in einer heissen Pfanne an. Geben Sie es in den Ofen.	75 Min.
P7	Roastbeef, Medium (Niedertemperatur Garen)			85 Min.
P8	Roastbeef, Well Done (durch) (Niedertemperatur Garen)			130 Min.
P9	Filet, blutig (Niedertemperatur Garen)	0,5–1,5 kg, 5–6 cm dicke Stücke	 2 ; Backblech Verwenden Sie Ihre liebsten Gewürze oder einfach nur Salz und frisch gemahlene(n) Pfeffer. Braten Sie das Fleisch einige Min.uten in einer heissen Pfanne an. Geben Sie es in den Ofen.	75 Min.
P10	Filet, Medium (Niedertemperatur Garen)			90 Min.
P11	Filet, Well Done (durch) (Niedertemperatur Garen)			120 Min.
Kalb 				
P12	Kalbsbraten (z. B. Schulter)	0,8–1,5 kg, 4 cm dicke Stücke	 2 ; Braten der Speise auf dem Git-terrost Verwenden Sie Ihre liebsten Gewürze. Fügen Sie Flüssigkeit hinzu. Abgedeckt garen.	80 Min.











TÄGLICHER GEBRAUCH

	Speise	Gewicht	Einschubebene/Zubehör	Garzeit
Schweinefleisch 				
P13	Schweinebraten, Hals oder Schulter	1,5–2 kg	  2; Speise auf Gitterrost braten Wenden Sie das Fleisch nach der Hälfte der Garzeit.	120 Min.
P14	Pulled Pork (Niedertemperatur Garen)	1,5–2 kg	 2; Backblech Verwenden Sie Ihre liebsten Gewürze. Wenden Sie das Fleisch nach der Hälfte der Garzeit für eine gleichmässige Bräunung.	215 Min.
P15	Nierenstück, frisch	1–1,5 kg; 5–6 cm dicke Stücke	 2; Speise auf Gitterrost braten Verwenden Sie Ihre liebsten Gewürze.	55 Min.
P16	Spare Ribs	2–3 kg; nehmen Sie 2–3 cm dünnen Brustspitz	 3; tiefes Blech Fügen Sie Flüssigkeit hinzu, um den Boden der Bratform zu bedecken. Wenden Sie das Fleisch nach der Hälfte der Garzeit.	90 Min
Lamm 				
P17	Lammhaxe mit Knochen	1,5–2 kg; 7–9 cm dicke Stücke	 2; Speise auf Backblech garen Fügen Sie Flüssigkeit hinzu. Wenden Sie das Fleisch nach der Hälfte der Garzeit.	130 Min.
Geflügel 				
P18	Poulet, ganz	1–1,5 kg; frisch	  2; Auflaufform auf Backblech Verwenden Sie Ihre liebsten Gewürze. Wenden Sie das Huhn nach der Hälfte der Backzeit für eine gleichmässige Bräunung.	60 Min.
P19	Halbes Poulet	0,5–0,8 kg	 3; Backblech Verwenden Sie Ihre liebsten Gewürze.	40 Min.

	Speise	Gewicht	Einschubebene/Zubehör	Garzeit
P20	Pouletbrust	180–200 g pro Stück	  2; Auflaufform auf Gitterrost Verwenden Sie Ihre liebsten Gewürze. Braten Sie das Fleisch einige Min.uten in einer heissen Pfanne an.	25 Min.
P21	Pouletschenkel, frisch	-	 3; Backblech Wenn die Pouletschenkel mariniert sind, garen Sie sie länger und bei niedrigerer Temperatur.	30 Min.
P22	Ente, ganz	2–3 kg	  2; Braten der Speise auf dem Gitterrost Verwenden Sie Ihre liebsten Gewürze. Legen Sie das Fleisch in einen Bräter. Wenden Sie die Ente nach der Hälfte der Garzeit.	100 Min.
P23	Gans, ganz	4–5 kg	  2; tiefes Blech Verwenden Sie Ihre liebsten Gewürze. Legen Sie das Fleisch auf ein tiefes Backblech. Wenden Sie die Gans nach der Hälfte der Garzeit.	110 Min.
Sonstiges 				
P24	Hackbraten	1 kg	 2; Gitterrost Verwenden Sie Ihre liebsten Gewürze.	60 Min.
Fisch 				
P25	Ganzer Fisch, grilliert	0,5–1 kg pro Fisch	 2; Backblech Füllen Sie den Fisch mit Butter und verwenden Sie Ihre liebsten Gewürze und Kräuter.	30 Min.
P26	Fischfilet	-	  3; Auflaufform auf Gitterrost Verwenden Sie Ihre liebsten Gewürze.	20 Min.
Gebäck/Süssspeisen   				



TÄGLICHER GEBRAUCH

	Speise	Gewicht	Einschubebene/Zubehör	Garzeit
P27	Käsekuchen	-	 2;  28 cm Blech-Springform auf Gitterrost	90 Min
P28	Apfelkuchen	-	 3; Backblech	45 Min.
P29	Apfeltorte	-	 2; Kuchenform Gitterrost	40 Min.
P30	Apfeltorte	-	 1;  22 cm Kuchenform auf Gitterrost	60 Min.
P31	Brownies	2 kg	 3; tiefes Kuchenblech	30 Min.
P32	Schokoladen-Muffins	-	 3; Muffin-Blech auf Gitterrost	25 Min.
P33	Kastenkuchen	-	 2; Kastenform auf Gitterrost	50 Min.
Gemüse/Beilagen   				
P34	Ofenkartoffeln	1 kg	 2; Backblech Legen Sie die ganzen Kartoffeln ungeschält auf ein Backblech.	50 Min.
P35	Wedges	1 kg	 3; Backblech mit Backpapier ausgelegt Verwenden Sie Ihre liebsten Gewürze. Schneiden Sie die Kartoffeln in Stücke.	35 Min.
P36	Gemischtes Grillgemüse	1–1,5 kg	 3; Backblech mit Backpapier ausgelegt Verwenden Sie Ihre liebsten Gewürze. Schneiden Sie das Gemüse in Stücke.	30 Min.
P37	Kroketten, gefroren	0,5 kg	 3; Backblech	25 Min.
P38	Pommes frites, gefroren	0,75 kg	 3; Backblech	25 Min.
Gratins, Brot und Pizza   				

	Speise	Gewicht	Einschubebene/Zubehör	Garzeit
P39	Fleisch/ Gemüse-La- sagne mit tro- ckenen Nu- delplatten	1–1,5 kg	 2; Auflaufform auf Gitterrost	45 Min.
P40	Kartoffelgra- tin (rohe Kar- toffeln)	1–1,5 kg	 1; Auflaufform auf Gitterrost Drehen Sie das Gratin nach der Hälfte der Garzeit.	50 Min.
P41	Pizza, frisch, dünn	-	  2; Backblech ausgelegt mit Back- papier	15 Min
P42	Pizza, frisch, dick	-	  2; Backblech ausgelegt mit Back- papier	25 Min.
P43	Quiche	-	 2; Backblech auf Gitterrost	45 Min.
P44	Baguette/ Ciabatta/ Weissbrot	0,8 kg	  3; Backblech mit Backpapier aus- gelegt Für Weissbrot ist die Backzeit länger.	30 Min.
P45	Vollkorn-/ Roggen-/ dunkles Mehr- kornbrot in Laibform	1 kg	  2; Backblech mit Backpapier aus- gelegt/ Gitterrost	60 Min.

7. UHRFUNKTIONEN



7.1 Uhrfunktionen





Uhrfunktion	Anwendung
	Kurzzeit-Wecker. Wenn die Zeit abgelaufen ist, ertönt ein Signalton.
	Garzeit. Wenn das Endsignal des Timers ertönt, stoppt die Ofenfunktion.
	Zeitverzögerung. Zum Verzögern von Start und/oder Ende des Garvorgangs.

UHRFUNKTIONEN







Uhrfunktion	Anwendung
	Uptimer. Max. 23 Std. 59 Min. Diese Funktion hat keine Auswirkung auf den Ofenbetrieb. Um die Uptimer ein- und auszustellen, wählen Sie: Menü, Einstellungen.

7.2 Einstellung: Uhrfunktionen

Einstellung: Uhrzeit		
Schritt 1	Schritt 2	Schritt 3
		
Zum Ändern der Uhrzeit gehen Sie ins Menü und wählen Einstellungen, Uhrzeit.	Stellen Sie die Uhr ein.	Drücken Sie: OK.

Einstellung: Kurzzeit-Wecker			
Schritt 1	Im Display erscheint: 0:00 	Schritt 2	Schritt 3
			
Drücken Sie:  .		Stellen Sie den Kurzzeit-Wecker ein.	Drücken Sie: OK.
 Der Timer beginnt sofort mit dem Rückwärtszählen.			

VERWENDUNG: ZUBEHÖRTEILE

Einstellung: Garzeit					
Schritt 1	Schritt 2	Im Display er- scheint: 0:00  STOP	Schritt 3	Schritt 4	
					
Stellen Sie eine Ofenfunktion und die Temperatur ein.	Wiederholt drücken:  .			Stellen Sie die Gardauer ein.	Drücken Sie: OK.
ⓘ Der Timer beginnt sofort mit dem Rückwärtszählen.					

Einstellung: Zeitverzögerung									
Schritt 1	Schritt 2	Auf dem Display wird die eingestellte Zeit angezeigt.  START	Schritt 3	Schritt 4	Im Display er- scheint: --:--  STOPP	Schritt 5	Schritt 6		
									
Wählen Sie die Ofenfunktion.	Wiederholt drücken:  .			Stellen Sie die Startzeit ein.		Drücken Sie: OK.		Stellen Sie die Endzeit ein.	Drücken Sie: OK.
ⓘ Der Timer beginnt zur eingestellten Startzeit mit dem Rückwärtszählen.									

8. VERWENDUNG: ZUBEHÖRTEILE



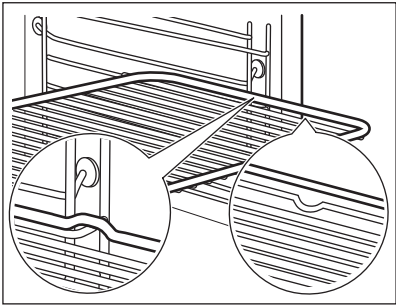
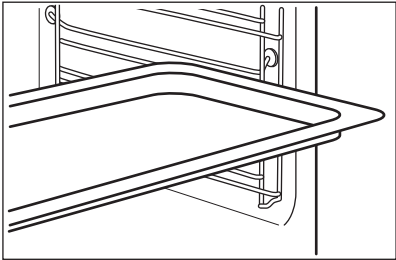

8.1 Einsetzen der Zubehörteile

Eine kleine Kerbe oben sorgt für mehr Sicherheit. Die Kerben verhindern auch ein Umkippen. Der hohe Rand um den Rost verhindert das Abrutschen von Kochgeschirr.

<p>Gitterrost: Schieben Sie den Gitterrost zwischen die Führungsstäbe des Einhängegitters.</p>	
<p>Backblech: Schieben Sie das Blech zwischen die Führungsstäbe der Einhängegitter.</p>	



9. ZUSATZFUNKTIONEN

9.1 Verriegelung

<p>Diese Funktion verhindert eine versehentliche Änderung der Gerätefunktion.</p>		
<p>Schalten Sie sie ein, wenn das Gerät funktioniert – der eingestellte Garvorgang wird fortgesetzt, das Bedienfeld ist gesperrt. Schalten Sie sie ein, wenn das Gerät ausgeschaltet ist – es lässt sich nicht einschalten, das Bedienfeld ist gesperrt.</p>		
	<p> drücken und halten, um die Funktion einzuschalten. Ein Signalton ertönt.</p>	<p> – drücken und halten, um die Funktion auszuschalten.</p>
<p> 3 x  – blinkt, wenn die Sperre eingeschaltet ist.</p>		

9.2 Abschaltautomatik

Der Ofen wird aus Sicherheitsgründen nach einiger Zeit ausgeschaltet, wenn eine Ofenfunktion eingeschaltet ist und Sie die Einstellungen nicht ändern.

 (°C)	 (Std.)
30 - 115	12.5
120 - 195	8.5
200 - 245	5.5
250 °C – Höchsttemperatur	3

Die Abschaltautomatik funktioniert nicht mit den folgenden Funktionen: Backofenbeleuchtung, Zeitverzögerung.



9.3 Kühlgebläse

Wenn das Gerät in Betrieb ist, wird das Kühlgebläse automatisch eingeschaltet, um die Geräteoberflächen zu kühlen. Nach dem Abschalten des Geräts läuft das Kühlgebläse weiter, bis das Gerät abgekühlt ist.



10. RATSCHLÄGE UND TIPPS

10.1 Feuchte Umluft

Für beste Ergebnisse befolgen Sie die in der Tabelle unten aufgeführten Empfehlungen. Nutzen Sie die dritte Einschubebene.



	 (°C)	 (Min.)
Nudel-Auflauf	200 - 220	45 - 55
Kartoffelgratin	180 - 200	70 - 85
Moussaka	170 - 190	70 - 95
Lasagne, frisch	180 - 200	75 - 90
Cannelloni	180 - 200	70 - 85
Brotpudding	190 - 200	55 - 70
Milchreis	170 - 190	45 - 60

RATSCHLÄGE UND TIPPS

	 (°C)	 (Min.)
Apfelkuchen aus Biskuitteig (runde Kuchenform)	160 - 170	70 - 80
Weissbrot	190 - 200	55 - 70

10.2 Feuchte Umluft - empfohlenes Zubehör

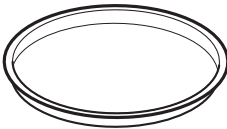
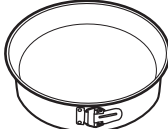





Verwenden Sie dunkle und nicht reflektierende Formen und Behälter. Diese nehmen die Wärme besser auf als helle und reflektierende Behälter.

			
Pizzapfanne	Auflaufform	Ramekins	Tortenbodenform
Dunkel, nicht reflektierend 28 cm Durchmesser	Dunkel, nicht reflektierend 26 cm Durchmesser	Keramik 8 cm Durchmesser, 5 cm hoch	Dunkel, nicht reflektierend 28 cm Durchmesser

10.3 Gartabellen für Prüfinstitute





Informationen für Prüfinstitute

Prüfungen nach: EN 60350, IEC 60350.

 BACKEN AUF EINER EINSCHUBEBENE. Backen in Formen				
		 (°C)	 (min)	
Biskuitkuchen (fettfrei)	Heissluft	140–150	35–50	2
Biskuitkuchen (fettfrei)	Ober-/Unterhitze	160	35–50	2
Apfeltorte, 2 Formen à Ø 20 cm	Heissluft	160	60–90	2



BACKEN AUF EINER EINSCHUBELENE. Backen in Formen





		 (°C)	 (min)	
Apfeltorte, 2 Formen à Ø 20 cm	Ober-/Unterhitze	180	70–90	1



BACKEN AUF EINER EINSCHUBELENE. Plätzchen







Nutzen Sie die dritte Einschubebene.

		 (°C)	 (min)
Buttergebäck / Feingebäck	Heissluft	140	25–40
Buttergebäck / Feingebäck, heizen Sie den leeren Backofen vor	Ober-/Unterhitze	160	20–30
Törtchen, 20 pro Blech, heizen Sie den leeren Backofen vor	Heissluft	150	20–35
Törtchen, 20 pro Blech, heizen Sie den leeren Backofen vor	Ober-/Unterhitze	170	20–30

REINIGUNG UND PFLEGE



BACKEN AUF MEHREREN EBENEN. Plätzchen

		 (°C)	 (min)	
Buttergebäck / Feingebäck	Heissluft	140	25–45	1 / 4
Törtchen, 20 pro Blech, heizen Sie den leeren Backofen vor	Heissluft	150	23–40	1 / 4
Biskuitkuchen (fettfrei)	Heissluft	160	35–50	1 / 4







GRILL



Heizen Sie den leeren Ofen 5 Minuten lang vor.



Grillen Sie bei Höchstemtemperatureinstellung.

		 (min)	
Toast	Grill	1–3	5
Rindersteak, nach der Hälfte der Zeit wenden	Grill	24–30	4



11. REINIGUNG UND PFLEGE



WARNUNG!

Siehe Kapitel „Sicherheitshinweise“.

11.1 Hinweise zur Reinigung

 <p>Reinigungs- mittel</p>	Reinigen Sie die Oberfläche des Geräts nur mit einem Mikrofasertuch, warmem Wasser und einem milden Reinigungsmittel.
	Verwenden Sie eine Reinigungslösung zum Reinigen der Metalloberflächen.
	Beseitigen Sie Flecken mit einem milden Reinigungsmittel.
 <p>Alltäglicher Gebrauch</p>	Reinigen Sie den Garraum nach jedem Gebrauch. Fettansammlungen oder andere Rückstände können einen Brand verursachen.
	Lassen Sie Speisen nicht länger als 20 Minuten im Gerät stehen. Trocknen Sie den Garraum nach jedem Gebrauch nur mit einem Mikrofasertuch.
 <p>Zubehörteile</p>	Reinigen Sie das gesamte Zubehör nach jedem Gebrauch und lassen sie es trocknen. Verwenden Sie nur ein Mikrofasertuch, warmes Wasser und ein mildes Reinigungsmittel. Reinigen Sie das Zubehör nicht in einem Geschirrspüler.
	Reinigen Sie das Antihafz Zubehör nicht mit aggressiven Mitteln oder scharfkantigen Gegenständen.

11.2 Entfernen der: Einhängegitter

Entfernen Sie zum Reinigen des Ofens die Einhängegitter.

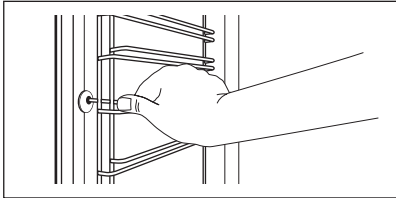
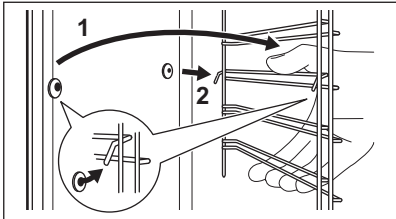
Schritt 1	Schalten Sie den Backofen aus und warten Sie, bis er abgekühlt ist.	
Schritt 2	Ziehen Sie das Vordere der Eihängegitter von der Seitenwand ab.	
Schritt 3	Ziehen Sie das Eihängegitter hinten von der Seitenwand ab, und nehmen Sie es vollständig heraus.	
Schritt 4	Führen Sie zum Einsetzen der Eihängegitter die obigen Schritte in umgekehrter Reihenfolge aus.	

11.3 Entfernen: Grill



WARNUNG!

Es besteht Verbrennungsgefahr.

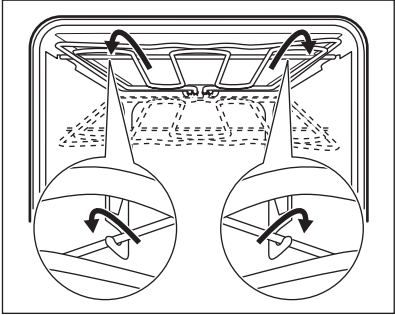
Schritt 1	Schalten Sie den Ofen aus und lassen Sie ihn völlig abkühlen, bevor Sie ihn reinigen. Entfernen Sie die Einhängegitter.	
Schritt 2	Fassen Sie die Ecken des Grills. Ziehen Sie ihn gegen die Federkraft nach vorne und aus beiden Halterungen heraus. Der Grill lässt sich abklappen.	
Schritt 3	Reinigen Sie die Ofendecke mit warmem Wasser, einem weichen Tuch und einem milden Reinigungsmittel. Lassen Sie sie trocknen.	
Schritt 4	Führen Sie zum Einbauen des Grills die Schritte in umgekehrter Reihenfolge durch.	
Schritt 5	Setzen Sie die Einhängegitter wieder ein.	

11.4 Aus- und Einbau: Tür

Die Tür und die inneren Glasscheiben können zur Reinigung ausgebaut werden. Die Anzahl Glasscheiben unterscheidet sich von anderen Modellen.



WARNUNG!

Die Tür ist schwer.



VORSICHT!

Geben Sie bei der Handhabung der Glasscheiben vorsichtig vor, insbesondere an den Kanten der Frontscheibe. Das Glas kann brechen.

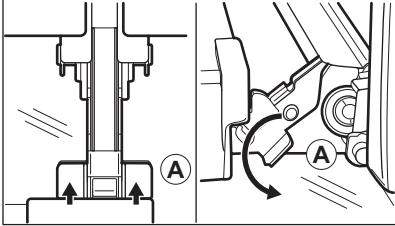
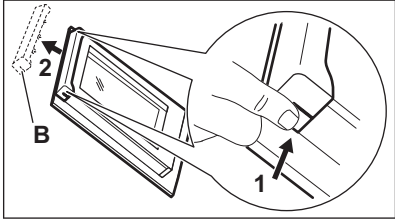
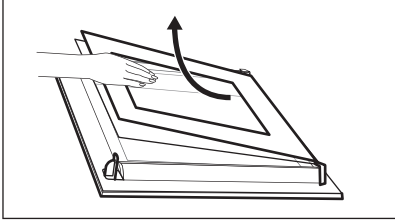
Schritt 1	Öffnen Sie die Tür vollständig.	
Schritt 2	Heben Sie die Klemmhebel (A) an beiden Türscharnieren an und drücken Sie auf sie.	
Schritt 3	Schliessen Sie die Backofentür bis zur ersten Öffnungsstellung (Winkel ca. 70°). Fassen Sie die Tür auf beiden Seiten und ziehen Sie sie schräg nach oben vom Ofen weg. Legen Sie die Tür mit der Aussenseite nach unten auf ein weiches Tuch und eine stabile Fläche.	
Schritt 4	Fassen Sie die Türabdeckung (B) an der Oberkante der Tür an beiden Seiten an. Drücken Sie sie nach innen, um den Klippverschluss zu lösen.	
Schritt 5	Ziehen Sie die Türabdeckung nach vorne, um sie abzunehmen.	
Schritt 6	Fassen Sie die Glasscheiben der Tür nacheinander am oberen Rand an und ziehen Sie sie nach oben aus der Führung.	
Schritt 7	Reinigen Sie die Glasscheibe mit Wasser und Seife. Trocknen Sie die Glasscheibe sorgfältig ab. Reinigen Sie die Glasscheiben nicht im Geschirrspüler.	
Schritt 8	Führen Sie nach der Reinigung die oben aufgeführten Schritte in umgekehrter Reihenfolge durch.	
Schritt 9	Setzen Sie zuerst die kleinere Scheibe ein, dann die grössere Scheibe und die Tür. Achten Sie darauf, dass die Gläser in korrekter Position eingesetzt werden, da sich die Türoberfläche sonst überhitzen kann.	

FEHLERSUCHE

11.5 Wie ersetzt man: Lampe

**WARNUNG!**

Stromschlaggefahr.
Die Lampe kann heiss sein.

Bevor Sie die Lampe austauschen:

Schritt 1	Schritt 2	Schritt 3
Schalten Sie den Ofen aus. Warten Sie, bis der Ofen kalt ist.	Trennen Sie den Ofen von der Stromversorgung.	Legen Sie ein Tuch auf den Garraumboden.

Obere Lampe

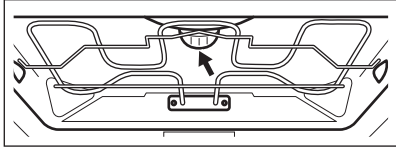
Schritt 1	Drehen Sie die Glasabdeckung und nehmen Sie sie ab.	
Schritt 2	Säubern Sie die Glasabdeckung.	
Schritt 3	Ersetzen Sie die Lampe durch eine bis 300 °C hitzebeständige Halogenlampe mit 230 V und 40 W.	
Schritt 4	Setzen Sie die Glasabdeckung wieder ein.	

12. FEHLERSUCHE

**WARNUNG!**

Siehe Kapitel „Sicherheitshinweise“.

12.1 Was tun, wenn ...

Bei Fällen, die nicht in dieser Tabelle aufgeführt sind, wenden Sie sich bitte an einen autorisierten Kundendienst.

**Der Backofen lässt sich nicht einschalten oder heizt nicht auf**

Problem	Prüfen Sie Folgendes:
---------	-----------------------



Der Backofen lässt sich nicht einschalten oder heizt nicht auf

Der Backofen kann nicht eingeschaltet oder bedient werden.	Der Backofen ist ordnungsgemäss an die Spannungsversorgung angeschlossen.
Der Backofen heizt nicht auf.	Die Abschaltautomatik ist deaktiviert.
Der Backofen heizt nicht auf.	Die Sicherung ist nicht durchgebrannt.
Der Backofen heizt nicht auf.	Die Verriegelung ist offen.



Komponenten

Problem	Prüfen Sie Folgendes:
Die Lampe ist ausgeschaltet.	Feuchte Umluft – ist eingeschaltet.
Die Lampe funktioniert nicht.	Die Lampe ist durchgebrannt.



Fehlercodes

Im Display wird Folgendes angezeigt:	Prüfen Sie Folgendes:
00:00	Es gab einen Stromausfall. Stellen Sie die Uhrzeit ein.

Wenn im Display ein Fehlercode angezeigt wird, der nicht in dieser Tabelle aufgeführt ist, schalten Sie die Haussicherung aus und ein und starten Sie den Backofen erneut. Wenn der Fehlercode erneut erscheint, wenden Sie sich an einen autorisierten Kundendienst.

12.2 Servicedaten

Wenn Sie selbst keine Lösung für das Problem finden, kontaktieren Sie Ihren Händler oder einen autorisierten Kundendienst.

Die erforderlichen Daten für den Kundendienst sind auf dem Typenschild zu finden. Das Typenschild befindet sich auf der vorderen Rahmen des Garraums. Das Typenschild darf nicht vom Garraum entfernt werden.

Wir empfehlen Ihnen, die Daten hier einzutragen:	
Modell (MOD.)
Produktnummer (PNC)
Seriennummer (S.N.)

13. ENERGIEEFFIZIENZ

13.1 Produktinformationen und Produktinformationsblatt

Name des Lieferanten	Electrolux	
Modell-Kennzeichnung	EH7L4CN 948533595 EH7L4SW 948533596 EH7L4WE 948533597	
Energieeffizienzindex	81,2	
Energieeffizienzklasse	A+	
Energieverbrauch bei einer Standardlast, konventioneller Betrieb	1,09 kWh/Programm	
Energieverbrauch bei Standardbeladung, forcierte Heissluft	0,69 kWh/Programm	
Anzahl der Hohlräume	1	
Wärmequelle	Elektrizität	
Volumen	71 l	
Backofentyp	Einbauherd	
Gewicht	EH7L4CN	39.0 kg
	EH7L4SW	39.0 kg
	EH7L4WE	39.0 kg

IEC/EN 60350-1 – Elektrische Kochgeräte für den Hausgebrauch – Teil 1: Herde, Backöfen, Dampfgarer und Grillgeräte – Verfahren zur Messung der Gebrauchseigenschaften.

13.2 Energie sparen



Das Gerät verfügt über Funktionen, mit deren Hilfe Sie beim Kochen Energie sparen können.

Achten Sie darauf, dass die Gerätetür bei Betrieb des Geräts ordnungsgemäss geschlossen ist. Öffnen Sie während des Garens die Gerätetür nicht zu häufig. Halten Sie die Türdichtung sauber und achten Sie darauf, dass sie sicher sitzt.

Verwenden Sie Metallgeschirr, um mehr Energie zu sparen.

Wenn möglich, das Gerät vor dem Garen nicht vorheizen.

Backen Sie in möglichst kurzen Abständen, wenn Sie einige Gerichte gleichzeitig zubereiten.

Garen mit Heissluft

Verwenden Sie nach Möglichkeit die Ofenfunktionen mit Heissluft, um Energie zu sparen.

Restwärme

Der Ventilator und die Lampe bleiben weiterhin eingeschaltet. Das Display zeigt die Restwärme an, sobald Sie das Gerät ausschalten. Sie können die Restwärme zum Warmhalten der Speisen benutzen.

Wenn die Garzeit länger als 30 Min. ist, reduzieren Sie die Gerätetemperatur vor Ende des Garvorgangs auf mindestens 3–10 Min. Die Restwärme im Gerät gart die Speisen weiter.

Nutzen Sie die Restwärme, um andere Speisen aufzuwärmen.

Warmhalten von Speisen

Wählen Sie die niedrigste Temperatureinstellung, um die Restwärme zum Warmhalten von Speisen zu nutzen. Die Restwärmeanzeige oder Temperatur erscheint auf dem Display.

Garen mit ausgeschalteter Backofenbeleuchtung

Schalten Sie die Beleuchtung während des Garens aus. Schalten Sie sie nur bei Bedarf ein.

Feuchte Umluft

Funktion dient zum Energiesparen beim Kochen.

Wenn Sie diese Funktion verwenden, wird die Backofenlampe nach 30 Sekunden automatisch ausgeschaltet. Sie können die Backofenbeleuchtung wieder einschalten, aber dadurch werden die erwarteten Energieeinsparungen reduziert.



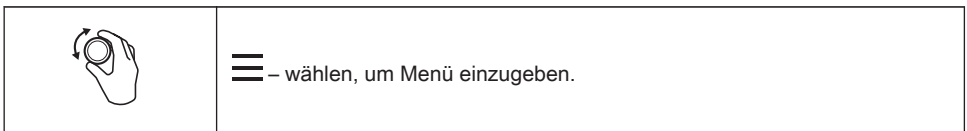

14. MENÜSTRUKTUR

14.1 Menü



Menü-Struktur				
VarioGuide		Einstellungen		
Schritt 1	Schritt 2	Schritt 3	Schritt 4	Schritt 5

MENÜSTRUKTUR

	 OK	 01-10	 OK	
Wählen Sie Menü, Einstellungen.	Bestätigen Sie die Einstellung.	Wählen Sie die Einstellung.	Bestätigen Sie die Einstellung.	Passen Sie den Wert an und drücken Sie OK.

Einstellungen					
O1	Uhrzeit	Stellen Sie bei	O2	Helligkeit	1 - 5
O3	Tastentöne	1 – Piepen 2 – Klicken 3 – Ton aus	O4	Lautstärke	1 - 4
O5	Uptimer	Ein/Aus	O6	Backofenbeleuchtung	Ein/Aus
O7	Schnellaufheizung	Ein/Aus	O8	DEMO	Aktivierungscode: 2468
O9	Softwareversion	Prüfen	O10	Gerät auf Werkseinstellungen zurücksetzen	Ja/Nein

15. GARANTIE

Kundendienst

Servicestellen		
Industriestrasse 10 5506 Mägenwil	Le Trési 6 1028 Préverenges	Via Violino 11 6928 Manno



Servicestellen	
Morgenstrasse 131 3018 Bern	 <p>Service-Helpline 0848 848 111 service@electrolux.ch</p>
Langgasse 10 9008 St. Gallen	
Am Mattenhof 4a/b 6010 Kriens	
Schlossstrasse 1 4133 Pratteln	
Comercialstrasse 19 7000 Chur	

Ersatzteilverkauf Industriestrasse 10, 5506 Mägenwil, Tel. 0848 848 111

Fachberatung/Verkauf Badenerstrasse 587, 8048 Zürich, Tel. 044 405 81 11

Garantie Für jedes Produkt gewähren wir ab Verkauf bzw. Lieferdatum an den Endverbraucher eine Garantie von 2 Jahren. (Ausweis durch Garantieschein, Faktura oder Verkaufsbeleg). Die Garantieleistung umfasst die Kosten für Material, Arbeits- und Reisezeit. Die Garantieleistung entfällt bei Nichtbeachtung der Gebrauchsanweisung und Betriebsvorschriften, unsachgerechter Installation, sowie bei Beschädigung durch äussere Einflüsse, höhere Gewalt, Eingriffe Dritter und Verwendung von Nicht-Original Teilen.

16. UMWELTTIPPS

Recyceln Sie Materialien mit dem Symbol . Entsorgen Sie die Verpackung in den entsprechenden Recyclingbehältern. Recyceln Sie zum Umwelt- und Gesundheitsschutz elektrische und elektronische Geräte. Entsorgen Sie Geräte mit dem Symbol  nicht mit dem Hausmüll. Bringen Sie das Gerät zu Ihrer örtlichen Sammelstelle oder wenden Sie sich an Ihr Gemeindeamt.



Für die Schweiz:

Wohin mit den Altgeräten?

Überall dort wo neue Geräte verkauft werden oder Abgabe bei den offiziellen SENS-Sammelstellen oder offiziellen SENS-Recyclern.

Die Liste der offiziellen SENS-Sammelstellen findet sich unter www.erecycling.ch

NOUS PENSONS À VOUS

Merci d'avoir choisi un appareil Electrolux. Vous avez choisi un produit qui bénéficie de décennies d'expérience professionnelle et d'innovation. Ingénieux et élégant, il a été pensé pour vous. C'est la raison pour laquelle vous pouvez avoir la certitude d'obtenir d'excellents résultats à chaque utilisation.

Bienvenue chez Electrolux
Consultez notre site pour :



Obtenir des conseils d'utilisation, des brochures, un dépanneur, des informations sur le service et les réparations :

www.electrolux.com/support



Enregistrer votre produit pour un meilleur service :

www.registerelectrolux.com



Acheter des accessoires, consommables et pièces de rechange d'origine pour votre appareil :

www.electrolux.com/shop



Pour plus de recettes, conseils, informations de dépannage, téléchargez l'application **My Electrolux Kitchen**.



SERVICE ET ASSISTANCE À LA CLIENTÈLE

N'utilisez que des pièces de rechange d'origine.

Avant de contacter notre centre de service agréé, assurez-vous de disposer des informations suivantes : Modèle, PNC, numéro de série.

Ces informations figurent sur la plaque signalétique.

 Avertissement/Consignes de sécurité

 Informations générales et conseils

 Informations environnementales

Sous réserve de modifications.

TABLE DES MATIÈRES

1. INFORMATION SUR LA SÉCURITÉ.....	39	2.6 Service.....	45
1.1 Sécurité des enfants et des personnes vulnérables.....	40	2.7 Mise au rebut.....	45
1.2 Sécurité générale.....	40	3. DESCRIPTION DE L'APPAREIL.....	46
2. CONSIGNES DE SÉCURITÉ.....	42	3.1 Vue d'ensemble.....	46
2.1 Installation.....	42	3.2 Accessoires.....	46
2.2 Branchement électrique.....	43	4. BANDEAU DE COMMANDE.....	47
2.3 Utilisation.....	43	4.1 Manettes rétractables.....	47
2.4 Entretien et Nettoyage.....	44	4.2 Manettes des zones de cuisson....	47
2.5 Éclairage interne.....	44	4.3 Réglages de la température.....	47

4.4 Utilisation de la double zone (si disponible).....	47	10.2 Circulation d'air humide - accessoires recommandés.....	61
4.5 Touches tactiles du bandeau de commande.....	48	10.3 Tableaux de cuisson pour les instituts de tests.....	61
5. AVANT LA PREMIÈRE UTILISATION.....	48	11. ENTRETIEN ET NETTOYAGE.....	63
5.1 Nettoyage initial.....	49	11.1 Remarques concernant le nettoyage.....	64
5.2 Préchauffage initial.....	49	11.2 Comment retirer : Supports de grille	64
6. UTILISATION QUOTIDIENNE.....	49	11.3 Comment enlever : Gril.....	65
6.1 Comment régler : Modes de cuisson.....	49	11.4	
6.2 Modes de cuisson.....	50	Comment démonter et installer : Porte.....	65
6.3 Remarques sur : Circulation d'air humide.....	51	11.5 Comment remplacer : Éclairage..	66
6.4 Comment régler : Cuisson assistée.....	51	12. DÉPANNAGE.....	67
6.5 Cuisson assistée.....	52	12.1 Que faire si.....	67
7. FONCTIONS DE L'HORLOGE.....	57	12.2 Données de maintenance.....	68
7.1 Fonctions de l'horloge.....	57	13. RENDEMENT ÉNERGÉTIQUE.....	68
7.2 Comment régler : Fonctions de l'horloge.....	58	13.1 Informations produits et fiche d'informations produits.....	68
8. CONSEILS D'UTILISATION : ACCESSOIRES.....	59	13.2 Économie d'énergie.....	69
8.1 Insertion des accessoires.....	59	14. STRUCTURE DES MENUS.....	70
9. FONCTIONS SUPPLÉMENTAIRES.....	60	14.1 Menu	70
9.1 Touches Verrouil.....	60	15. GARANTIE.....	71
9.2 Arrêt automatique.....	60	16. EN MATIÈRE DE PROTECTION DE L'ENVIRONNEMENT.....	72
9.3 Ventilateur de refroidissement.....	60		
10. CONSEILS.....	60		
10.1 Circulation d'air humide.....	60		

1. ⚠ INFORMATION SUR LA SÉCURITÉ

Avant d'installer et d'utiliser cet appareil, lisez soigneusement les instructions fournies. Le fabricant ne pourra être tenu pour responsable des blessures et dégâts résultant d'une mauvaise installation ou utilisation. Conservez toujours les instructions dans un lieu sûr et accessible pour vous y référer ultérieurement.

1.1 Sécurité des enfants et des personnes vulnérables

- Cet appareil peut être utilisé par des enfants âgés d'au moins 8 ans et par des personnes ayant des capacités physiques, sensorielles ou mentales réduites ou dénuées d'expérience ou de connaissance, s'ils sont correctement surveillés ou si des instructions relatives à l'utilisation de l'appareil en toute sécurité leur ont été données et s'ils comprennent les risques encourus. Les enfants de moins de 8 ans et les personnes ayant un handicap très important et complexe doivent être tenus à l'écart de l'appareil, à moins d'être surveillés en permanence.
- Veillez à ce que les enfants ne jouent pas avec l'appareil.
- Ne laissez pas les emballages à la portée des enfants et jetez-les convenablement.
- **AVERTISSEMENT** : L'appareil et ses parties accessibles deviennent chauds pendant l'utilisation. Tenez les enfants et les animaux éloignés de l'appareil lorsqu'il est en cours d'utilisation et de refroidissement.
- Si l'appareil est équipé d'un dispositif de sécurité enfants, nous vous recommandons de l'activer.
- Le nettoyage et l'entretien par l'utilisateur ne doivent pas être effectués par des enfants sans surveillance.

1.2 Sécurité générale

- Cet appareil est exclusivement destiné à un usage culinaire.
- Cet appareil est conçu pour un usage domestique unique, dans un environnement intérieur.
- Cet appareil peut être utilisé dans les bureaux, les chambres d'hôtel, les chambres d'hôtes, les maisons d'hôtes de ferme et d'autres hébergements similaires lorsque cette utilisation ne dépasse pas le niveau (moyen) de l'utilisation domestique.

- Cet appareil doit être installé et le câble remplacé uniquement par un professionnel qualifié.
- N'utilisez pas l'appareil avant de l'avoir installé dans la structure encastrée.
- Débranchez l'appareil de l'alimentation électrique avant toute opération d'entretien.
- Si le câble d'alimentation secteur est endommagé, son remplacement doit être confié exclusivement au fabricant, à son service après-vente ou à toute autre personne qualifiée afin d'éviter tout danger électrique.
- Le bandeau de commande doit être raccordé à une résistance adaptée en respectant les couleurs des connecteurs pour éviter tout risque.
- Un moyen de déconnexion doit être prévu dans le câblage fixe conformément aux règles nationales d'installation.
- **AVERTISSEMENT** : Assurez-vous que l'appareil est éteint avant de remplacer l'ampoule pour éviter tout risque d'électrocution.
- **AVERTISSEMENT** : L'appareil et ses parties accessibles deviennent chauds pendant l'utilisation. Des précautions doivent être prises pour éviter de toucher les éléments chauffants ou la surface de la cavité de l'appareil.
- Utilisez toujours des gants de cuisine pour retirer ou insérer des accessoires ou des plats allant au four.
- Pour retirer les supports de grille, tirez d'abord l'avant du support de grille, puis l'arrière à distance des parois latérales. Installez les supports de grille dans l'ordre inverse.
- N'utilisez pas de nettoyeur à vapeur pour nettoyer l'appareil.
- N'utilisez pas de produits abrasifs ni de racloirs pointus en métal pour nettoyer la porte en verre car ils peuvent rayer la surface, ce qui peut briser le verre.

2. CONSIGNES DE SÉCURITÉ

2.1 Installation

**AVERTISSEMENT!**

L'appareil doit être installé uniquement par un professionnel qualifié.

- Retirez l'intégralité de l'emballage.
- N'installez pas et ne branchez pas un appareil endommagé.
- Suivez scrupuleusement les instructions d'installation fournies avec l'appareil.
- Soyez toujours vigilants lorsque vous déplacez l'appareil car il est lourd. Utilisez toujours des gants de sécurité et des chaussures fermées.
- Ne tirez jamais l'appareil par la poignée.
- Installez l'appareil dans un lieu sûr et adapté répondant aux exigences d'installation.
- Les dimensions du meuble de cuisine et de la niche d'encastrement doivent être appropriées.
- Respectez l'espacement minimal requis par rapport aux autres appareils et éléments.
- Avant de monter l'appareil, vérifiez si la porte de l'appareil s'ouvre sans retenue.
- Certaines pièces de l'appareil sont électrifiées. Placez l'appareil de façon à éviter que l'on puisse toucher les pièces dangereuses.
- L'appareil est équipé d'un système de refroidissement électrique. Il doit être utilisé avec l'alimentation électrique.
- L'unité intégrée doit répondre aux exigences de stabilité de la norme DIN 68930.

Hauteur minimale du meuble (Hauteur minimale du meuble sous le plan de travail)	762 (762) mm
Largeur du meuble	550 mm
Profondeur du meuble	605 (580) mm
Hauteur de l'avant de l'appareil	757 mm
Hauteur de l'arrière de l'appareil	739 mm
Largeur de l'avant de l'appareil	549 mm
Largeur de l'arrière de l'appareil	548 mm
Profondeur de l'appareil	567 mm
Profondeur d'encastrement de l'appareil	546 mm
Profondeur avec porte ouverte	1017 mm

Dimensions minimales de l'ouverture de ventilation. Ouverture placée sur la partie inférieure de la face arrière	550 x 20 mm
Vis de montage	4x12 mm

2.2 Branchement électrique



AVERTISSEMENT!

Risque d'incendie ou d'électrocution.

- Tous les raccordements électriques doivent être effectués par un électricien qualifié.
- L'appareil doit être relié à la terre.
- Assurez-vous que les paramètres figurant sur la plaque signalétique correspondent aux données électriques nominale de l'alimentation secteur.
- Utilisez toujours une prise de courant de sécurité correctement installée.
- N'utilisez pas d'adaptateurs multiprise et de rallonges.
- Veillez à ne pas endommager la fiche secteur ni le câble d'alimentation. Le remplacement du câble d'alimentation de l'appareil doit être effectué par notre service après-vente agréé.
- Ne laissez pas les câbles d'alimentation entrer en contact ou s'approcher de la porte de l'appareil ou de la niche d'encastrement sous l'appareil, particulièrement lorsqu'il est en marche ou que la porte est chaude.
- La protection contre les chocs des parties sous tension et isolées doit être fixée de telle manière qu'elle ne puisse pas être enlevée sans outils.
- Ne branchez la fiche secteur dans la prise secteur qu'à la fin de l'installation. Assurez-vous que la prise secteur est accessible après l'installation.
- Si la prise secteur est détachée, ne branchez pas la fiche secteur.
- Ne tirez pas sur le câble secteur pour débrancher l'appareil. Tirez toujours sur la fiche de la prise secteur.
- N'utilisez que des systèmes d'isolation appropriés : des coupe-circuits, des fusibles (les fusibles à visser doivent être retirés du support), un disjoncteur différentiel et des contacteurs.
- L'installation électrique doit comporter un dispositif d'isolation qui vous permet de déconnecter l'appareil du secteur à tous les pôles. Le dispositif d'isolement doit avoir une largeur d'ouverture de contact de 3 mm minimum.
- Cet appareil est fourni sans fiche électrique ni câble d'alimentation.

2.3 Utilisation



AVERTISSEMENT!

Risque de blessures, de brûlures, d'électrocution ou d'explosion.

- Ne modifiez pas les spécifications de cet appareil.
- Assurez-vous que les orifices d'aération ne sont pas obstrués.
- Ne laissez pas l'appareil sans surveillance durant son fonctionnement.
- Éteignez l'appareil après chaque utilisation.
- Soyez prudent lors de l'ouverture de la porte de l'appareil lorsque celui-ci fonctionne. De l'air chaud peut se dégager.
- N'utilisez pas l'appareil avec des mains mouillées ou en contact avec de l'eau.

CONSIGNES DE SÉCURITÉ

- N'exercez pas de pression sur la porte ouverte.
- N'utilisez pas l'appareil comme plan de travail ou comme espace de rangement.
- Ouvrez la porte de l'appareil avec précaution. L'utilisation d'ingrédients avec de l'alcool peut provoquer un mélange d'alcool et d'air.
- Ne laissez pas des étincelles ou des flammes nues entrer en contact avec l'appareil lorsque vous ouvrez la porte.
- Ne placez pas de produits inflammables ou d'éléments imbibés de produits inflammables à l'intérieur, à proximité ou au-dessus de l'appareil.



AVERTISSEMENT!

Risque d'endommagement de l'appareil.

- Pour éviter tout endommagement ou décoloration de l'émail :
 - ne posez pas de plats allant au four ou d'autres objets directement dans le fond de l'appareil.
 - ne placez jamais de feuilles d'aluminium directement sur le fond de la cavité de l'appareil.
 - ne versez pas d'eau directement dans l'appareil chaud.
 - ne conservez pas de plats et de nourriture humides dans l'appareil après avoir terminé la cuisson.
 - Installez ou retirez les accessoires avec précautions.
- La décoloration de l'émail ou de l'acier inoxydable est sans effet sur les performances de l'appareil.
- Utilisez un plat à rôtir pour des gâteaux moelleux. Les jus de fruits provoquent des taches qui peuvent être permanentes.
- Cuisinez toujours avec la porte de l'appareil fermée.

2.4 Entretien et Nettoyage



AVERTISSEMENT!

Risque de blessure, d'incendie ou de dommages matériels sur l'appareil.

- Avant toute opération d'entretien, éteignez l'appareil et débranchez la fiche de la prise secteur.
- Vérifiez que l'appareil est froid. Les panneaux de verre risquent de se briser.
- Remplacez immédiatement les vitres de la porte si elles sont endommagées. Contactez le service après-vente agréé.
- Soyez prudent lorsque vous retirez la porte de l'appareil. La porte est lourde !
- Nettoyez régulièrement l'appareil afin de maintenir le revêtement en bon état.
- Nettoyez l'appareil avec un chiffon doux humide. Utilisez uniquement des produits de lavage neutres. N'utilisez pas de produits abrasifs, de tampons à récurer, de solvants ni d'objets métalliques.
- Si vous utilisez un spray pour four, suivez les consignes de sécurité figurant sur son emballage.

2.5 Éclairage interne



AVERTISSEMENT!

Risque d'électrocution !

- Concernant la/les lampe(s) à l'intérieur de ce produit et les lampes de rechange vendues séparément : Ces lampes sont conçues pour résister à des conditions physiques extrêmes

dans les appareils électroménagers, telles que la température, les vibrations, l'humidité, ou sont conçues pour signaler des informations sur le statut opérationnel de l'appareil. Elles ne sont pas destinées à être utilisées dans d'autres applications et ne conviennent pas à l'éclairage des pièces d'un logement.

- Ce produit contient une source lumineuse de classe d'efficacité énergétique G.
- Utilisez uniquement des ampoules ayant les mêmes spécifications.

2.6 Service

- Pour réparer l'appareil, contactez le service après-vente agréé.
- Utilisez uniquement des pièces de rechange d'origine.

2.7 Mise au rebut



AVERTISSEMENT!

Risque de blessure ou d'asphyxie.

- Contactez votre service municipal pour obtenir des informations sur la marche à suivre pour mettre l'appareil au rebut.
- Débranchez l'appareil de l'alimentation électrique.
- Coupez le câble d'alimentation au ras de l'appareil et mettez-le au rebut.
- Retirez le dispositif de verrouillage du hublot pour empêcher les jeunes et les animaux de s'enfermer dans l'appareil.

3. DESCRIPTION DE L'APPAREIL

3.1 Vue d'ensemble

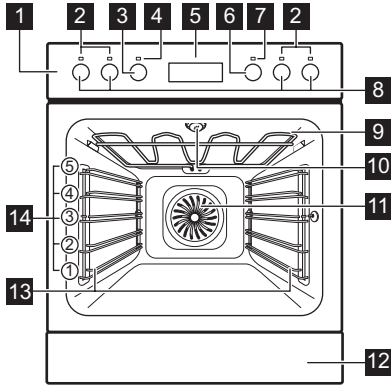

- 1** Bandeau de commande
- 2** Voyants/symboles des zones de cuisson
- 3** Manette de sélection des modes de cuisson
- 4** Voyant / symbole de mise sous tension
- 5** Affichage
- 6** Manette de commande
- 7** Indicateur / symbole de température
- 8** Manettes des zones de cuisson
- 9** Résistance
- 10** Éclairage
- 11** Chaleur tournante
- 12** Réservoir
- 13** Support de grille, amovible
- 14** Niveaux de la grille

3.2 Accessoires

Grille métallique

Pour les plats de cuisson, les moules à gâteaux, les rôtis.

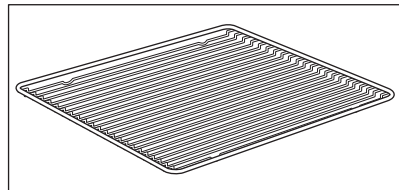

Plateau de cuisson

Pour les gâteaux et biscuits.

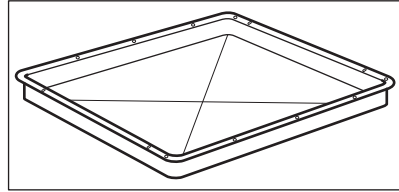

4. BANDEAU DE COMMANDE

4.1 Manettes rétractables

Pour utiliser l'appareil, appuyez sur la manette. La manette sort alors de son logement.

4.2 Manettes des zones de cuisson





AVERTISSEMENT!

Reportez-vous au chapitre « Sécurité » de la notice d'utilisation de la table de cuisson.

Vous pouvez utiliser la table de cuisson avec les manettes des zones de cuisson.

4.3 Réglages de la température

Indication du sélecteur	Fonction
0	Position d'arrêt
	Maintien au chaud
1 - 9	Réglages de la température
	Interrupteur à double zone

Tournez la manette pour régler un niveau de cuisson souhaité.

4.4 Utilisation de la double zone (si disponible)









Pour activer la double zone, tournez la manette vers la droite. Ne la tournez pas jusqu'à la position Arrêt.

1. Tournez la manette vers la droite jusqu'à la position 9.
2. Tournez lentement la manette jusqu'au symbole  jusqu'à ce que vous entendiez un clic. Les deux zones de cuisson sont activées.
3. Pour ajuster le niveau de puissance nécessaire, reportez-vous au chapitre « Niveaux de cuisson ».

AVANT LA PREMIÈRE UTILISATION







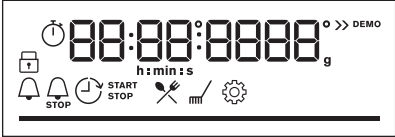

4.5 Touches tactiles du bandeau de commande

				OK		
Minuteur	Pré-chauffage rapide	Eclairage four	Touches Verrouil	Confirmez la configuration	Appuyez sur la touche	Tournez la manette

Sélectionnez un mode de cuisson pour allumer le four.

Tournez la manette des modes de cuisson sur la position Arrêt pour mettre à l'arrêt le four.

	Affichage avec les principales fonctions.
---	---

Voyants de l'affichage :	 Touches Verrouil.	 Cuisson assistée	 Configurations	 Préchauffage rapide
Voyants du minuteur :				
Barre de progression - de la température ou de l'heure. La barre est entièrement rouge lorsque le four atteint la température réglée.				

5. AVANT LA PREMIÈRE UTILISATION





AVERTISSEMENT!

Reportez-vous aux chapitres concernant la sécurité.

5.1 Nettoyage initial

Avant la première utilisation, nettoyez le four à vide et réglez la durée :			
			 00:00 Réglez l'heure. Appuyez sur la touche OK.

5.2 Préchauffage initial

 Préchauffez le four à vide avant de l'utiliser pour la première fois.	
Étape 1	Retirez les supports de grille amovibles et tous les accessoires du four.
Étape 2	Réglez la température maximale pour la fonction :  Laissez le four fonctionner pendant 1 heure.
Étape 3	Réglez la température maximale pour la fonction :  Laissez le four fonctionner pendant 15 minutes.
ⓘ Une odeur et de la fumée peuvent s'échapper du four durant le préchauffage. Assurez-vous que la pièce est ventilée.	



6. UTILISATION QUOTIDIENNE



AVERTISSEMENT!

Réportez-vous aux chapitres concernant la sécurité.







6.1 Comment régler : Modes de cuisson





Étape 1	Étape 2
 	 °C

Sélectionnez un mode de cuisson.	Réglez la température. Appuyez sur la touche OK .
 - maintenez la touche enfoncée pour activer la fonction : Préchauffage rapide. Disponible avec certaines fonctions du four.	

6.2 Modes de cuisson

Modes de cuisson standard

Mode de cuisson	Application
 Chaleur tournante	Pour faire cuire sur 3 niveaux en même temps et pour sécher des aliments. Diminuez les températures de 20 à 40 °C par rapport à la Chauffage Haut/Bas.
 Chauffage Haut/Bas	Pour cuire et rôtir des aliments sur un seul niveau.
 Plats Surgelés	Pour rendre croustillants vos plats préparés, tels que frites, pommes quartiers et nems.
 Fonction Pizza	Pour cuire des pizzas. Pour faire dorer de façon intensive et obtenir un dessous croustillant.
 Cuisson de sole	Pour cuire des gâteaux à fond croustillant et pour stériliser des aliments.
 Décongélation	Pour décongeler des aliments (fruits et légumes). Le temps de décongélation dépend de la quantité et de la grosseur des plats surgelés.

Mode de cuisson	Application
 Circulation d'air humide	<p>Cette fonction est conçue pour économiser de l'énergie en cours de cuisson. Lorsque vous utilisez cette fonction, la température à l'intérieur de la cavité peut différer de la température sélectionnée. La chaleur résiduelle est utilisée. La puissance peut être réduite. Pour plus d'informations, consultez la partie sur les remarques du chapitre « Utilisation quotidienne ». Circulation d'air humide.</p>
 Gril	<p>Pour faire griller des aliments peu épais et du pain.</p>
 Turbo gril	<p>Pour rôti de gros morceaux de viande ou de volaille avec os sur un seul niveau. Pour gratiner et faire dorer.</p>
 Menu	<p>Pour accéder au menu : Cuisson assistée, Nettoyage, Configurations.</p>

6.3 Remarques sur : Circulation d'air humide

Cette fonction était utilisée pour se conformer à la classe d'efficacité énergétique et aux exigences Ecodesign (selon les normes EU 65/2014 et UE 66/2014). Tests conformes aux normes :

IEC/EN 60350-1

La porte du four doit être fermée pendant la cuisson pour que la fonction ne soit pas interrompue et que le four fonctionne avec la plus grande efficacité énergétique possible. Lorsque vous utilisez cette fonction, l'éclairage s'éteint automatiquement au bout de 30 secondes.

Pour consulter les instructions de cuisson, reportez-vous au chapitre « Conseils », Circulation d'air humide. Pour obtenir des recommandations générales sur l'économie d'énergie, reportez-vous au chapitre « Efficacité énergétique », « Économie d'énergie ».







6.4 Comment régler : Cuisson assistée

Chaque plat apparaissant dans ce sous-menu a une fonction et une température recommandées. Vous pouvez régler la durée et la température pendant la cuisson.



<p>Pour certains plats, vous pouvez également réaliser la cuisson avec :</p>	<ul style="list-style-type: none"> • Poids automatique
--	---

Cuisson assistée - vous pouvez l'utiliser pour préparer un plat rapidement avec les réglages par défaut :			
Étape 1	Étape 2	Étape 3	Étape 4





Cuisson assistée - vous pouvez l'utiliser pour préparer un plat rapidement avec les réglages par défaut :











 	 	 P1 - P45	 OK
Accédez au menu.	Sélectionner Cuisson assistée. Appuyez sur OK .	Sélectionnez le plat. Appuyez sur la touche OK .	Placez le plat dans le four. Confirmez la configuration.

6.5 Cuisson assistée













Légende	
	Poids automatique disponible.
	Préchauffez le four avant de commencer la cuisson.
	Niveau de grille.

















Lorsque la fonction se termine, vérifiez si les aliments sont prêts.

	Plat	Poids	Niveau/Accessoire	Durée
Bœuf 				
P1	Rôti de bœuf, saignant	1 - 1,5 kg ; 4 - 5 cm d'épaisseur	 2 ; plateau de cuisson Faire frire la viande pendant quelques minutes sur une poêle chaude. Insérez au four.	40 min
P2	Rôti de bœuf, à point			50 min
P3	Rôti de bœuf, bien cuit			60 min
P4	Steak de bœuf, à point	180 - 220 g par pièce ; 3 cm d'épaisseur	  3 ; plat à rôtir sur grille métallique Faire frire la viande pendant quelques minutes sur une poêle chaude. Insérez au four.	15 min













	Plat	Poids	Niveau/Accessoire	Durée
P5	Bœuf rôti/ braisé (côte de bœuf, intérieur de ronde, flanchet)	1,5 - 2 kg	  2 ; plat à rôtir sur grille métallique Faire frire la viande pendant quelques minutes sur une poêle chaude. Ajoutez du liquide. Insérez au four.	120 min
P6	Rôti de bœuf, saignant (cuisson basse température)	1 - 1,5 kg ; 4 - 5 cm d'épaisseur	 2 ; plateau de cuisson Servez-vous de vos épices préférées ou simplement du sel et du poivre fraîchement moulu. Faire frire la viande pendant quelques minutes sur une poêle chaude. Insérez au four.	75 min
P7	Rôti de bœuf, à point (cuisson basse température)			85 min
P8	Rôti de bœuf, bien cuit (cuisson basse température)			130 min
P9	Filet, saignant (cuisson basse température)	0,5 - 1,5 kg ; 5 - 6 cm d'épaisseur	 2 ; plateau de cuisson Servez-vous de vos épices préférées ou simplement du sel et du poivre fraîchement moulu. Faire frire la viande pendant quelques minutes sur une poêle chaude. Insérez au four.	75 min
P10	Filet, à point (cuisson basse température)			90 min
P11	Filet, bien cuit (cuisson basse température)			120 min
Veau 				
P12	Rôti de veau (par ex. épaule)	0,8 - 1,5 kg ; 4 cm d'épaisseur	  2 ; plat à rôtir sur grille métallique Utilisez vos épices préférées. Ajoutez du liquide. Rôti couvert.	80 min
Porc 				
P13	Rôti de porc - collet ou épaule	1,5 - 2 kg	  2 ; plat à rôtir sur grille métallique Retournez la viande à la moitié du temps de cuisson.	120 min









UTILISATION QUOTIDIENNE

	Plat	Poids	Niveau/Accessoire	Durée
P14	Émincé de porc (cuisson lente)	1,5 - 2 kg	 2 ; plateau de cuisson Utilisez vos épices préférées. Retournez la viande à la moitié du temps de cuisson pour faire dorer de manière homogène.	215 min
P15	Longe, fraîche	1 - 1,5 kg ; 5 - 6 cm d'épaisseur	 2 ; plat à rôtir sur grille métallique Utilisez vos épices préférées.	55 min
P16	Travers	2 - 3 kg ; crus, 2 - 3 cm d'épaisseur	 3 plat profond Ajoutez du liquide pour recouvrir le fond d'un plat. Retournez la viande à la moitié du temps de cuisson.	90 min
Agneau 				
P17	Gigot d'agneau avec os	1,5 - 2 kg ; 7 - 9 cm d'épaisseur	 2 ; plat à rôtir sur plateau de cuisson Ajoutez du liquide. Retournez la viande à la moitié du temps de cuisson.	130 min
Volaille 				
P18	Poulet entier	1 - 1,5 kg ; frais	  2 ; cocotte sur plateau de cuisson Utilisez vos épices préférées. Retournez le poulet à la moitié du temps de cuisson pour faire dorer de manière homogène.	60 min
P19	Demi poulet	0,5 - 0,8 kg	 3 ; plateau de cuisson Utilisez vos épices préférées.	40 min
P20	Escalope de poulet	180 - 200 g par pièce	  2 ; cocotte sur grille métallique Utilisez vos épices préférées. Faire frire la viande pendant quelques minutes sur une poêle chaude.	25 min
P21	Cuisses de poulet, fraîches	-	 3 ; plateau de cuisson Si vous avez mariné les cuisses de poulet, réglez une température inférieure et faites-les cuire plus longtemps.	30 min

	Plat	Poids	Niveau/Accessoire	Durée
P22	Canard entier	2 - 3 kg	 2 ; plat à rôtir sur grille métallique Utilisez vos épices préférées. Placez la viande sur un plat à rôtir. Retournez le canard à la moitié du temps de cuisson.	100 min
P23	Oie entière	4 - 5 kg	 2 ; plat profond Utilisez vos épices préférées. Placez la viande sur un plateau de cuisson profond. Retournez l'oie à la moitié du temps de cuisson.	110 min
Autres 				
P24	Rôti haché	1 kg	 2 ; grille métallique Utilisez vos épices préférées.	60 min
Poisson 				
P25	Poisson entier, grillé	0,5 - 1 kg par poisson	 2 ; plateau de cuisson Remplissez le poisson avec du beurre et utilisez vos épices et herbes préférées.	30 min
P26	Filet de poisson	-	 3 ; cocotte sur grille métallique Utilisez vos épices préférées.	20 min
Gâteaux/desserts   				
P27	Cheesecake	-	 2 ;  moule à charnière de 28 cm sur grille métallique	90 min
P28	Gâteau aux pommes	-	 3 ; plateau de cuisson	45 min
P29	Tarte aux pommes	-	 2 ; moule à tarte sur grille métallique	40 min
P30	Tarte aux pommes	-	 1 ;  moule à tarte de 22 cm sur grille métallique	60 min
P31	Brownies	2 kg	 3 ; plat profond	30 min





UTILISATION QUOTIDIENNE

	Plat	Poids	Niveau/Accessoire	Durée
P32	Muffins au chocolat	-	 3 ; bac à muffins sur grille métallique	25 min
P33	Quatre-quarts	-	 2 ; moule quatre-quarts sur grille métallique	50 min
Légumes/Garnitures 				
P34	Pommes de terre au four	1 kg	 2 ; plateau de cuisson Placez les pommes de terre entières avec la peau sur un plateau de cuisson.	50 min
P35	Quartiers	1 kg	 3 ; plateau de cuisson recouvert de papier sulfurisé Utilisez vos épices préférées. Coupez les pommes de terre en morceaux.	35 min
P36	Mélange de légumes grillés	1 - 1,5 kg	 3 ; plateau de cuisson recouvert de papier sulfurisé Utilisez vos épices préférées. Coupez les légumes en morceaux.	30 min
P37	Croquettes surgelées	0,5 kg	 3 ; plateau de cuisson	25 min
P38	Pommes, surgelées	0,75 kg	 3 ; plateau de cuisson	25 min
Gratins, pain et pizza   				
P39	Lasagnes de viande / légumes avec assiettes de nouilles sèches	1 - 1,5 kg	 2 ; cocotte sur grille métallique	45 min
P40	Gratin de pommes de terre (pommes de terre crues)	1 - 1,5 kg	 1 ; cocotte sur grille métallique Tournez le plat après la moitié du temps de cuisson.	50 min



	Plat	Poids	Niveau/Accessoire	Durée
P41	Pizza fraîche, fine	-	  2 ; plateau de cuisson recouvert de papier sulfurisé	15 min
P42	Pizza fraîche, épaisse	-	  2 ; plateau de cuisson recouvert de papier sulfurisé	25 min
P43	Quiche	-	 2 ; plat de cuisson sur grille métallique	45 min
P44	Baguette/ Ciabatta/Pain blanc	0,8 kg	  3 ; plateau de cuisson recouvert de papier sulfurisé Prolonger le temps pour le pain blanc.	30 min
P45	Tous grains/ seigle/pain complet grains entiers dans un moule à pain	1 kg	  2 ; plateau de cuisson recouvert de papier sulfurisé / grille métallique	60 min







7. FONCTIONS DE L'HORLOGE







7.1 Fonctions de l'horloge

Fonctions de l'horloge	Application
	Minuteur. Lorsque le minuteur termine le décompte, le signal sonore retentit.
	Heure de cuisson. Lorsque le minuteur termine le décompte, le signal sonore retentit et le mode de cuisson s'arrête.
	Départ différé. Pour différer le début et/ou la fin de la cuisson.
	Compteur. Le maximum est de 23 h 59 min. Cette fonction n'a aucun effet sur le fonctionnement du four. Pour activer et désactiver le Compteur, sélectionnez : Menu , Configurations.











7.2 Comment régler : Fonctions de l'horloge

Comment régler Heure actuelle		
Étape 1	Étape 2	Étape 3
		
Pour modifier l'heure actuelle, accédez au menu et sélectionnez Configurations, Heure actuelle.	Réglez l'horloge.	Appuyez sur OK.

Comment régler Minuteur			
Étape 1	L'affichage indique : 0:00 	Étape 2	Étape 3
			
Appuyez sur : 		Réglez la Minuteur	Appuyez sur OK.
 Le minuteur commence son décompte immédiatement.			

Comment régler Heure de cuisson				
Étape 1	Étape 2	L'affichage indique : 0:00  STOP	Étape 3	Étape 4
				
Choisissez le mode de cuisson et réglez la température.	Appuyez à plusieurs reprises : 		Réglez le temps de cuisson.	Appuyez sur OK.
 Le minuteur commence son décompte immédiatement.				

CONSEILS D'UTILISATION : ACCESSOIRES

Comment régler Départ différé							
Étape 1	Étape 2		Étape 3	Étape 4		Étape 5	Étape 6
		L'affichage indique : l'heure actuelle			L'affichage indique : --:--		
Sélectionnez le mode de cuisson.	Appuyez à plusieurs reprises : 	 DÉ-MAR-RER	Réglez l'heure de départ.	Appuyez sur OK.	 AR-RÊTER	Réglez l'heure de fin.	Appuyez sur OK.
 Le minuteur commence à compter à l'heure réglée.							

8. CONSEILS D'UTILISATION : ACCESSOIRES

8.1 Insertion des accessoires

Une petite indentation sur le dessus apporte plus de sécurité. Les indentations sont également des dispositifs anti-bascule. Le rebord élevé de la grille empêche les ustensiles de cuisine de glisser sur la grille.

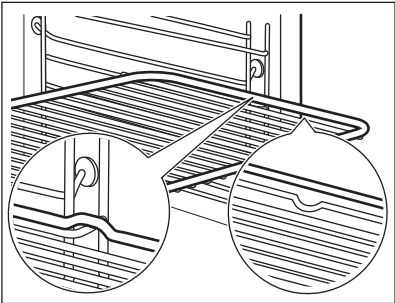
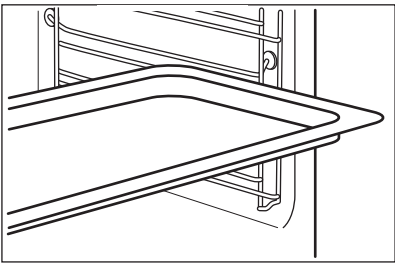
<p>Grille métallique: Poussez la grille entre les barres de guidage des supports de grille.</p>	
<p>Plateau de cuisson: Poussez la plaque entre les rails du support de grille.</p>	

9. FONCTIONS SUPPLÉMENTAIRES

9.1 Touches Verrouil.

Cette fonction permet d'éviter une modification involontaire de la fonction de l'appareil.

Activez-la lorsque l'appareil est allumé - la cuisson réglée est maintenue, le bandeau de commande est verrouillé.

Allumez-le lorsque l'appareil est éteint - il ne peut pas être allumé, le bandeau de commande est verrouillé.





 - maintenez la touche enfoncée pour activer la fonction. Un signal sonore retentit.

 - maintenez la touche enfoncée pour la désactiver.

 3 x  - clignote lorsque le verrouillage est activé.

9.2 Arrêt automatique

Pour des raisons de sécurité, le four s'éteint au bout d'un certain temps si un mode de cuisson est en cours et vous ne modifiez aucun réglage.

 (°C)	 (h)
30 - 115	12.5
120 - 195	8.5
200 - 245	5.5
250 -maximum	3

L'arrêt automatique ne fonctionne pas avec les fonctions : Eclairage four, Départ différé.



9.3 Ventilateur de refroidissement

Lorsque l'appareil fonctionne, le ventilateur de refroidissement se met automatiquement en marche pour refroidir les surfaces de l'appareil. Si vous éteignez l'appareil, le ventilateur de refroidissement peut continuer à fonctionner jusqu'à ce que l'appareil refroidisse.

10. CONSEILS



10.1 Circulation d'air humide

Pour de meilleurs résultats, suivez les suggestions indiquées dans le tableau ci-dessous. Utilisez le troisième niveau de la grille.

	 (°C)	 (min)
Gratin de pâtes	200 - 220	45 - 55
Gratin de pommes de terre	180 - 200	70 - 85
Moussaka	170 - 190	70 - 95
Lasagnes	180 - 200	75 - 90
Cannelloni	180 - 200	70 - 85
Pudding au pain	190 - 200	55 - 70
Gâteau de riz	170 - 190	45 - 60
Gâteau aux pommes, à base de mélange de génoise (moule à gâteau rond)	160 - 170	70 - 80
Pain Blanc	190 - 200	55 - 70

10.2 Circulation d'air humide - accessoires recommandés

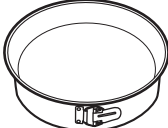
Utilisez les moules et récipients foncés et non réfléchissants. Ils offrent une meilleure absorption de la chaleur que les plats réfléchissants de couleur claire.

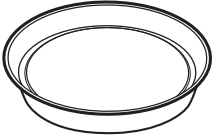
			
Plaque à pizza	Plat de cuisson	Ramequins	Moule pour fond de tarte
Sombre, non réfléchissant Diamètre de 28 cm	Sombre, non réfléchissant Diamètre : 26 cm	Céramique 8 cm de diamètre, 5 cm de hauteur	Sombre, non réfléchissant Diamètre de 28 cm

10.3 Tableaux de cuisson pour les instituts de tests





Informations pour les instituts de test

Tests conformes aux normes : EN 60350, IEC 60350.

CONSEILS



CUISSON SUR UN SEUL NIVEAU. Cuisson dans des moules





		 (°C)	 (min)	
Génoise allégée	Chaleur tournante	140 - 150	35 - 50	2
Génoise allégée	Chauffage Haut/Bas	160	35 - 50	2
Tarte aux pommes, 2 moules Ø20 cm	Chaleur tournante	160	60 - 90	2
Tarte aux pommes, 2 moules Ø20 cm	Chauffage Haut/Bas	180	70 - 90	1



CUISSON SUR UN SEUL NIVEAU. Biscuits/Gâteaux secs







Utilisez le troisième niveau de la grille.

		 (°C)	 (min)
Sablé / Tresses feuilletées	Chaleur tournante	140	25 - 40
Sablé / Tresses feuilletées, préchauffer le four à vide	Chauffage Haut/Bas	160	20 - 30
Petits gâteaux, 20 par plateau, préchauffer le four à vide	Chaleur tournante	150	20 - 35
Petits gâteaux, 20 par plateau, préchauffer le four à vide	Chauffage Haut/Bas	170	20 - 30



CUISSON SUR PLUSIEURS NIVEAUX. Biscuits/Gâteaux secs

		 (°C)	 (min)	
Sablé / Tresses feuilletées	Chaleur tournante	140	25 - 45	1 / 4
Petits gâteaux, 20 par plateau, préchauffer le four à vide	Chaleur tournante	150	23 - 40	1 / 4
Génoise allégée	Chaleur tournante	160	35 - 50	1 / 4







GRIL



Préchauffez toujours le four à vide pendant 5 minutes.



Réglez le gril à la température maximale.

		 (min)	
Pain grillé	Gril	1 - 3	5
Steak de bœuf, tourner à mi-cuisson	Gril	24 - 30	4



11. ENTRETIEN ET NETTOYAGE



AVERTISSEMENT!

Reportez-vous aux chapitres concernant la sécurité.

11.1 Remarques concernant le nettoyage

 <p>Agent nettoyant</p>	Nettoyez l'avant de l'appareil uniquement avec un chiffon en microfibre imbibé d'eau tiède et d'un détergent doux.
	Utilisez une solution de nettoyage pour nettoyer les surfaces métalliques.
	Nettoyez les taches avec un détergent doux.
 <p>Utilisation quotidienne</p>	Nettoyez la cavité après chaque utilisation. L'accumulation de graisse ou d'autres résidus peut provoquer un incendie.
	Ne conservez pas les aliments dans l'appareil pendant plus de 20 minutes. Séchez la cavité uniquement avec un chiffon en microfibre après chaque utilisation.
 <p>Accessoires</p>	Nettoyez tous les accessoires après chaque utilisation et laissez-les sécher. Utilisez uniquement un chiffon en microfibre avec de l'eau tiède et un détergent doux. Ne lavez pas les accessoires au lave-vaisselle.
	Ne nettoyez pas les accessoires anti-adhésifs avec un produit nettoyant abrasif ou des objets tranchants.

11.2 Comment retirer : Supports de grille

Retirez les supports de grille pour nettoyer le four.

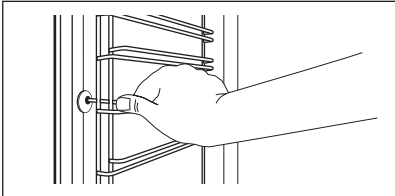
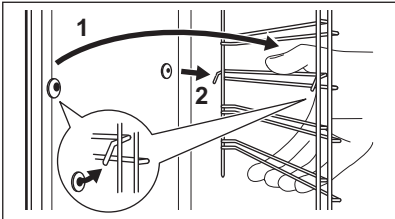
Étape 1	Éteignez le four et attendez qu'il soit froid.	
Étape 2	Écartez l'avant du support de grille de la paroi latérale.	
Étape 3	Écartez l'arrière du support de grille de la paroi latérale et retirez-le.	
Étape 4	Installez les supports de grille dans l'ordre inverse.	

11.3 Comment enlever : Gril



AVERTISSEMENT!

Risque de brûlure !

Étape 1	Éteignez le four et attendez qu'il soit froid pour le nettoyer. Retirez les supports de grille.	
Étape 2	Saisissez les coins de la grille. Tirez-la vers l'avant en surmontant la pression du ressort et sortez-la des deux supports. Le gril se replie.	
Étape 3	Nettoyez la voûte du four avec de l'eau chaude, un chiffon doux et un détergent doux. Laissez-la sécher.	
Étape 4	Installez le gril selon la même procédure, mais dans l'ordre inverse.	
Étape 5	Installez les supports de grille.	

11.4 Comment démonter et installer : Porte

Vous pouvez retirer la porte ainsi que les panneaux de verre intérieurs pour les nettoyer. Le nombre de vitres diffère selon les modèles.



AVERTISSEMENT!

La porte est lourde.



ATTENTION!

Manipulez soigneusement la vitre, en particulier autour des bords du panneau avant. Le verre peut se briser.

Étape 1	Ouvrez entièrement la porte.	
Étape 2	Soulevez et appuyez sur les leviers de blocage (A) sur les deux charnières de la porte.	

ENTRETIEN ET NETTOYAGE

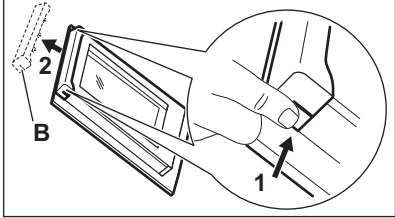
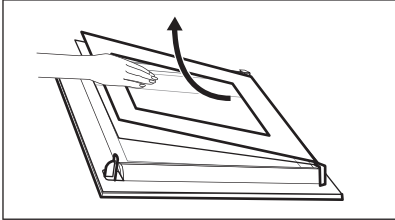
Étape 3	Fermez la porte du four à la première position (à un angle d'environ 70°). Tenez la porte des deux côtés et retirez-la du four en la soulevant. Posez la porte, face extérieure vers le bas, sur un linge doux posé sur une surface stable.	
Étape 4	Tenez la garniture de porte (B) sur le bord supérieur de la porte des deux côtés et poussez vers l'intérieur pour libérer le joint du clip.	
Étape 5	Retirez le cache de la porte en le tirant vers l'avant.	
Étape 6	Saisissez les panneaux de verre de la porte par leur bord supérieur un par un et dégagez-les du guide.	
Étape 7	Nettoyez la vitre à l'eau savonneuse. Essuyez soigneusement la vitre. Ne passez pas les panneaux en verre au lave-vaisselle.	
Étape 8	Après le nettoyage, effectuez les étapes ci-dessus dans le sens inverse.	
Étape 9	Installez d'abord le plus petit des panneaux, puis le plus grand, et terminez par la porte. Assurez-vous que les panneaux en verre sont insérés dans la bonne position, car la surface de la porte pourrait surchauffer.	

11.5 Comment remplacer : Éclairage



AVERTISSEMENT!

Risque d'électrocution.

L'éclairage peut être chaud.

Avant de remplacer l'éclairage :

Étape 1	Étape 2	Étape 3
Éteignez le four. Attendez que le four ait refroidi.	Débranchez le four de l'alimentation secteur.	Placez un chiffon au fond de la cavité.

Lampe supérieure

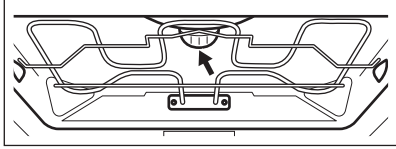
Étape 1	Tournez le diffuseur en verre pour le retirer.	
Étape 2	Nettoyez le diffuseur en verre.	
Étape 3	Remplacez l'ampoule par une ampoule halogène de 230 V, 40 W et résistant à une température de 300 °C.	
Étape 4	Installez le diffuseur en verre.	

12. DÉPANNAGE



AVERTISSEMENT!

Reportez-vous aux chapitres concernant la sécurité.

12.1 Que faire si...

Dans tous les cas ne figurant pas dans ce tableau, veuillez contacter un service après-vente agréé.



Le four ne fonctionne pas ou ne chauffe pas

Problème	Vérifiez si...
Vous ne pouvez pas activer le four ni la faire fonctionner.	Le four est correctement branché à l'alimentation électrique.
Le four ne chauffe pas.	L'arrêt automatique est désactivé.
Le four ne chauffe pas.	Le fusible n'a pas disjoncté.
Le four ne chauffe pas.	Le verrouillage est désactivé.



Composants

Problème	Vérifiez si...
----------	----------------

RENDEMENT ÉNERGÉTIQUE

 Composants	
L'éclairage est éteint.	La Circulation d'air humide est activée.
L'éclairage ne fonctionne pas.	L'ampoule est grillée.

 Codes d'erreur	
L'affichage indique...	Vérifiez si...
00:00	Une coupure de courant s'est produite. Réglez l'heure actuelle.
Si l'affichage indique un code d'erreur qui ne figure pas dans ce tableau, désactivez et réenclenchez le fusible de l'habitation pour redémarrer le four. Si le code d'erreur réapparaît, contactez un service après-vente agréé.	

12.2 Données de maintenance

Si vous ne trouvez pas de solution au problème, veuillez contacter votre revendeur ou un service après-vente agréé.

Les informations nécessaires au service après-vente figurent sur la plaque signalétique. La plaque signalétique se trouve sur le cadre avant de la cavité de l'appareil. Ne retirez pas la plaque signalétique de la cavité de l'appareil.

Nous vous recommandons d'écrire les informations ici :	
Modèle (Mod.)
Référence produit (PNC)
Numéro de série (SN)

13. RENDEMENT ÉNERGÉTIQUE

13.1 Informations produits et fiche d'informations produits

Nom du fournisseur	Electrolux
--------------------	------------

Identification du modèle	EH7L4CN 948533595 EH7L4SW 948533596 EH7L4WE 948533597	
Indice d'efficacité énergétique	81.2	
Classe d'efficacité énergétique	A+	
Consommation d'énergie avec charge standard, en mode conventionnel	1.09 kWh/cycle	
Consommation d'énergie avec charge standard, en mode chaleur tournante	0.69 kWh/cycle	
Nombre de cavités	1	
Source de chaleur	Électricité	
Volume	71 l	
Type de four	Four encastrable	
Masse	EH7L4CN	39.0 kg
	EH7L4SW	39.0 kg
	EH7L4WE	39.0 kg

IEC/EN 60350-1 - Appareils de cuisson domestiques électriques - Partie 1 : Cuisinières, fours, fours à vapeur et grils : Méthodes de mesure des performances.

13.2 Économie d'énergie



Cet appareil est doté de caractéristiques qui vous permettent d'économiser de l'énergie lors de votre cuisine au quotidien.

Assurez-vous que la porte de l'appareil est fermée lorsque l'appareil est en marche. Évitez d'ouvrir l'appareil trop souvent pendant la cuisson. Nettoyez régulièrement le joint de porte et assurez-vous qu'il est bien en place.

Utilisez des plats en métal pour accroître les économies d'énergie.

Dans la mesure du possible, ne préchauffez pas l'appareil avant la cuisson.

Lorsque vous préparez plusieurs plats à la fois, faites en sorte que les pauses entre les cuissons soient aussi courtes que possible.

Cuisson avec ventilation

Si possible, utilisez les fonctions de cuisson avec la ventilation pour économiser de l'énergie.

STRUCTURE DES MENUS

Chaleur résiduelle

L'éclairage et le ventilateur continuent de fonctionner. Lorsque vous mettez à l'arrêt l'appareil, l'affichage montre la chaleur résiduelle. Vous pouvez utiliser cette chaleur pour le maintien au chaud des aliments.

Si la cuisson doit durer plus de 30 minutes, réduisez la température de l'appareil au minimum 3 à 10 minutes avant la fin de la cuisson. La chaleur résiduelle à l'intérieur de l'appareil poursuivra la cuisson.

Utilisez la chaleur résiduelle pour réchauffer d'autres plats.

Maintien des aliments au chaud

Sélectionnez la température la plus basse possible pour utiliser la chaleur résiduelle et maintenir le repas au chaud. La température ou le voyant de chaleur résiduelle s'affichent.

Cuisson avec l'éclairage éteint

Éteignez l'éclairage en cours de cuisson. Ne l'allumez que lorsque vous en avez besoin.



Circulation d'air humide



Fonction conçue pour économiser de l'énergie en cours de cuisson.







Lorsque vous utilisez cette fonction, l'éclairage s'éteint automatiquement au bout de 30 secondes. Vous pouvez rallumer l'éclairage, mais cela réduira les économies d'énergie.

14. STRUCTURE DES MENUS

14.1 Menu

	 - sélectionnez pour accéder au Menu .
---	---

Structure du Menu	
Cuisson assistée 	Configurations 

Étape 1	Étape 2	Étape 3	Étape 4	Étape 5
 	 OK	 O1 - 10	 OK	
Sélectionnez le Menu , Configurations.	Confirmez la configuration.	Sélectionnez la configuration.	Confirmez la configuration.	Ajustez la valeur et appuyez sur OK.

Configurations					
O1	Heure actuelle	Modifier	O2	Affichage Luminosité	1 - 5
O3	Son touches	1 - Bip 2 - Clic 3 - Son dés-activé	O4	Volume alarme	1 - 4
O5	Compteur	Marche / Arrêt	O6	Eclairage four	Marche / Arrêt
O7	Préchauffage rapide	Marche / Arrêt	O8	Mode démo	Code d'activation : 2468
O9	Version du logiciel	Contrôle	O10	Réinitialiser tous les réglages	Oui/Non

15. GARANTIE

Service-clientèle

Points de Service		
Industriestrasse 10 5506 Mägenwil	Le Trési 6 1028 Prévèrenge	Via Violino 11 6928 Manno
Morgenstrasse 131 3018 Bern	 <p>Service-Helpline 0848 848 111 service@electrolux.ch</p>	
Langgasse 10 9008 St. Gallen		
Am Mattenhof 4a/b 6010 Kriens		
Schlossstrasse 1 4133 Pratteln		
Comercialstrasse 19 7000 Chur		

Points de vente de rechange Industriestrasse 10, 5506 Mägenwil, Tel. 0848 848 111



Conseil technique/Vente Badenerstrasse 587, 8048 Zürich, Tel. 044 405 81 11

Garantie Nous octroyons sur chaque produit 2 ans de garantie à partir de la date de livraison ou de la mise en service au consommateur (documenté au moyen d'une facture, d'un bon de

STRUCTURE DES MENUS

garantie ou d'un justificatif d'achat). Notre garantie couvre les frais de mains d'œuvres et de déplacement, ainsi que les pièces de rechange. Les conditions de garantie ne sont pas valables en cas d'intervention d'un tiers non autorisé, de l'emploi de pièces de rechange non originales, d'erreurs de maniement ou d'installation dues à l'inobservation du mode d'emploi, et pour des dommages causés par des influences extérieures ou de force majeure.

16. EN MATIÈRE DE PROTECTION DE L'ENVIRONNEMENT

Recyclez les matériaux portant le symbole . Déposez les emballages dans les conteneurs prévus à cet effet. Contribuez à la protection de l'environnement et à votre sécurité, recyclez vos produits électriques et électroniques. Ne jetez pas les appareils portant le symbole  avec les ordures ménagères. Emmenez un tel produit dans votre centre local de recyclage ou contactez vos services municipaux.



Pour la Suisse:

Où aller avec les appareils usagés ?

Partout où des appareils neufs sont vendus, mais aussi dans un centre de collecte ou une entreprise de récupération officiels SENS.

La liste des centres de collecte officiels SENS est disponible sous www.erecycling.ch

FR Concerne la France uniquement :



Points de collecte sur www.quefairedeমেdechets.fr
Privilégiez la réparation ou le don de votre appareil !

PENSIAMO A TE

Grazie per aver acquistato un elettrodomestico Electrolux. Hai scelto un prodotto che ha alle spalle decenni di esperienza professionale e innovazione. Ingegnoso ed elegante, è stato progettato pensando a te. Quindi, in qualsiasi momento lo utilizzi, avrai la certezza di ottenere sempre i migliori risultati.

Ti diamo il benvenuto in Electrolux.

Visitate il nostro sito web per:



Ricevere consigli, scaricare i nostri opuscoli, eliminare eventuali anomalie, ottenere informazioni sull'assistenza e la riparazione:

www.electrolux.com/support



Per registrare il vostro prodotto e ricevere un servizio migliore:

www.registerelectrolux.com



Acquistare accessori, materiali di consumo e ricambi originali per la vostra apparecchiatura:

www.electrolux.com/shop



Per ulteriori ricette, suggerimenti, indicazioni per la risoluzione dei problemi scaricare l'app **My Electrolux Kitchen**.



ASSISTENZA CLIENTI E ASSISTENZA TECNICA

Consigliamo sempre l'impiego di ricambi originali.

Quando si contatta il nostro Centro di Assistenza Autorizzato, accertarsi di avere a disposizione i dati seguenti: Modello, numero dell'apparecchio (PNC), numero di serie.

Le informazioni sono riportate sulla targhetta identificativa.

Avvertenza/Attenzione - Importanti Informazioni per la sicurezza

Informazioni generali e suggerimenti

Informazioni ambientali

Con riserva di modifiche.

INDICE

1. INFORMAZIONI DI SICUREZZA.....	74	2.6 Assistenza.....	79
1.1 Sicurezza di bambini e persone vulnerabili.....	74	2.7 Smaltimento.....	80
1.2 Avvertenze di sicurezza generali.....	75	3. DESCRIZIONE DEL PRODOTTO.....	80
2. ISTRUZIONI DI SICUREZZA.....	76	3.1 Panoramica generale.....	80
2.1 Installazione.....	76	3.2 Accessori.....	81
2.2 Collegamento elettrico.....	77	4. PANNELLO DEI COMANDI.....	81
2.3 Utilizzo.....	78	4.1 Manopola incassabile.....	81
2.4 Pulizia e cura.....	79	4.2 Manopole delle zone di cottura.....	81
2.5 Illuminazione interna.....	79	4.3 Livelli di potenza.....	81

4.4 Utilizzo della zona doppia (se presente).....	82	10.2 Cottura ventilata umida - accessori consigliati.....	95
4.5 Tasti sensore pannello dei comandi.....	82	10.3 Tabelle di cottura per gli istituti di test.....	96
5. PRIMA DEL PRIMO UTILIZZO.....	83	11. PULIZIA E CURA.....	98
5.1 Pulizia iniziale.....	83	11.1 Note sulla pulizia.....	98
5.2 Preriscaldamento iniziale.....	83	11.2 Come rimuovere: Supporti del ripiano	99
6. UTILIZZO QUOTIDIANO.....	83	11.3 Come togliere: Grill.....	99
6.1 Come impostare:		11.4 Procedura di rimozione e installazione: Porta.....	100
Funzioni cottura.....	83	11.5 Come sostituire: Lampadina.....	101
6.2 Funzioni cottura.....	84	12. RISOLUZIONE DEI PROBLEMI.....	102
6.3 Note su: Cottura ventilata umida..	85	12.1 Cosa fare se.....	102
6.4 Come impostare: Cottura guidata..	85	12.2 Dati dell'Assistenza.....	103
6.5 Cottura guidata.....	86	13. EFFICIENZA ENERGETICA.....	103
7. FUNZIONI DEL TIMER.....	91	13.1 Informazioni sul prodotto e scheda informativa sul prodotto.....	103
7.1 Funzioni orologio.....	91	13.2 Risparmio energetico.....	104
7.2 Come impostare: Funzioni Orologio.....	91	14. STRUTTURA DEL MENU.....	105
8. COME USARE: ACCESSORI.....	93	14.1 Menu.....	105
8.1 Inserimento di accessori.....	93	15. GARANZIA.....	106
9. FUNZIONI AGGIUNTIVE.....	94	16. CONSIDERAZIONI SULL'AMBIENTE..	107
9.1 Blocco.....	94		
9.2 Spegnimento automatico.....	94		
9.3 Ventola di raffreddamento.....	95		
10. CONSIGLI E SUGGERIMENTI UTILI.....	95		
10.1 Cottura ventilata umida.....	95		

1. INFORMAZIONI DI SICUREZZA

Leggere attentamente le istruzioni fornite prima di installare e utilizzare l'apparecchiatura. I produttori non sono responsabili di eventuali lesioni o danni derivanti da un'installazione o un uso scorretti. Conservare sempre le istruzioni in un luogo sicuro e accessibile per poterle consultare in futuro.

1.1 Sicurezza di bambini e persone vulnerabili

- Quest'apparecchiatura può essere usata da bambini a partire da 8 anni di età e da adulti con capacità fisiche, sensoriali o mentali limitate o con scarsa esperienza e conoscenza sull'uso dell'apparecchiatura, solamente se

sorvegliati o se istruiti relativamente all'utilizzo in sicurezza dell'apparecchiatura e se hanno compreso i rischi coinvolti. I bambini che hanno meno di 8 anni e le persone con disabilità diffuse e complesse vanno tenuti lontani dall'elettrodomestico, a meno che non vi sia una supervisione continua.

- I bambini devono essere sorvegliati per assicurarsi che non giochino con l'apparecchiatura.
- Tenere gli imballaggi lontano dai bambini e smaltirli in modo adeguato.
- **AVVERTENZA:** L'elettrodomestico e le parti accessibili si riscaldano molto durante l'uso. Tenere i bambini e gli animali domestici lontani dall'apparecchiatura durante l'uso e durante il raffreddamento.
- Se l'elettrodomestico ha un dispositivo di sicurezza per i bambini sarà opportuno attivarlo.
- I bambini non devono eseguire interventi di pulizia e manutenzione sull'elettrodomestico senza essere supervisionati.

1.2 Avvertenze di sicurezza generali

- L'apparecchiatura è destinata solo alla cottura.
- Quest'apparecchiatura è progettata per un uso domestico singolo in un ambiente interno.
- Quest'apparecchiatura può essere utilizzata in uffici, camere d'albergo, camere di bed & breakfast, alloggi in agriturismi e altre sistemazioni simili in cui tale utilizzo non superi i livelli di utilizzo domestico (medi).
- L'installazione dell'apparecchiatura e la sostituzione dei cavideve essere effettuata unicamente da personale qualificato.
- Non utilizzare l'apparecchiatura prima di installarla nella struttura a incasso.
- Prima di ogni operazione di manutenzione, scollegare l'apparecchiatura dall'alimentazione elettrica.

ISTRUZIONI DI SICUREZZA

- Se il cavo di alimentazione è danneggiato, deve essere sostituito dal produttore, da un centro di assistenza tecnica autorizzato o da una persona qualificata per evitare situazioni di pericolo elettrico.
- Il pannello di controllo deve essere collegato all'unità riscaldante indicata, abbinando i colori dei connettori per evitare possibili pericoli.
- I mezzi per lo scollegamento devono essere incorporati nel cablaggio fisso conformemente alle regole di cablaggio.
- **AVVERTENZA:** Assicurarsi che l'elettrodomestico sia spento prima di sostituire la lampadina per evitare la possibilità di scosse elettriche.
- **AVVERTENZA:** L'elettrodomestico e le parti accessibili si riscaldano molto durante l'uso. Prestare attenzione a non toccare le resistenze o la superficie della cavità dell'apparecchiatura.
- Utilizzare sempre guanti da forno per rimuovere o inserire accessori o pirofile.
- Per rimuovere i supporti del ripiano, tirare prima la parte anteriore del supporto del ripiano e poi l'estremità posteriore lontano dalle pareti laterali. Installare i supporti ripiani seguendo al contrario la procedura indicata.
- Non utilizzare vaporelle per pulire l'elettrodomestico.
- Non utilizzare detergenti abrasivi o raschietti di metallo per pulire il vetro dello sportello per non rigare la superficie e causare la rottura del vetro.

2. ISTRUZIONI DI SICUREZZA

2.1 Installazione

**AVVERTENZA!**

L'installazione dell'apparecchiatura deve essere eseguita da personale qualificato.

- Rimuovere tutti i materiali di imballaggio.
- Non installare o utilizzare l'apparecchiatura se è danneggiata.
- Attenersi alle istruzioni fornite insieme all'apparecchiatura.
- Prestare sempre attenzione in fase di spostamento dell'apparecchiatura, dato che è pesante. Usare sempre i guanti di sicurezza e le calzature adeguate.

- Non tirare l'apparecchiatura per la maniglia.
- Installare l'apparecchiatura in un luogo sicuro e idoneo che soddisfi i requisiti di installazione.
- Il mobile da incasso e il vano devono essere delle dimensioni adatte.
- È necessario rispettare la distanza minima dalle altre apparecchiature.
- Prima di montare l'apparecchiatura controllare che la porta dell'apparecchio si apra senza limitazioni.
- Alcune componenti dell'apparecchiatura trasmettono corrente. Chiudere l'apparecchiatura con il mobile per impedire il contatto con parti pericolose.
- L'apparecchiatura è dotata di un sistema di raffreddamento elettrico. Quest'ultimo funziona a corrente elettrica.
- L'unità a incasso deve soddisfare i requisiti di stabilità DIN 68930.

Altezza minima del mobiletto (mobiletto sotto all'altezza minima del piano di lavoro)	762 (762) mm
Larghezza del mobiletto	550 mm
Profondità del mobiletto	605 (580) mm
Altezza della parte anteriore dell'apparecchiatura	757 mm
Altezza della parte posteriore dell'apparecchiatura	739 mm
Larghezza della parte anteriore dell'apparecchiatura	549 mm
Larghezza della parte posteriore dell'apparecchiatura	548 mm
Profondità dell'apparecchiatura	567 mm
Profondità di incasso dell'apparecchiatura	546 mm
Profondità con porta aperta	1017 mm
Dimensioni minime dell'apertura di ventilazione. Apertura collocata sul lato posteriore inferiore	550 x 20 mm
Viti di montaggio	4x12 mm

2.2 Collegamento elettrico



AVVERTENZA!

Rischio di incendio e scossa elettrica.

- Tutti i collegamenti elettrici devono essere realizzati da un elettricista qualificato.
- L'apparecchiatura deve disporre di una messa a terra.

ISTRUZIONI DI SICUREZZA

- Verificare che i parametri sulla targhetta siano compatibili con le indicazioni elettriche dell'alimentazione.
- Utilizzare sempre una presa elettrica con contatto di protezione correttamente installata.
- Non utilizzare prese multiple e prolunghe.
- Accertarsi di non danneggiare la spina e il cavo. Qualora il cavo elettrico debba essere sostituito, l'intervento dovrà essere effettuato dal nostro Centro di Assistenza autorizzato.
- Evitare che i cavi entrino a contatto o si trovino vicino alla porta dell'apparecchiatura o sulla nicchia sotto all'apparecchiatura, in particolare quando il dispositivo è in funzione o la porta è calda.
- I dispositivi di protezione da scosse elettriche devono essere fissati in modo tale da non poter essere disattivati senza l'uso di attrezzi.
- Inserire la spina di alimentazione nella presa solo al termine dell'installazione. Verificare che la spina di alimentazione rimanga accessibile dopo l'installazione.
- Nel caso in cui la spina di corrente sia allentata, non collegarla alla presa.
- Non tirare il cavo di alimentazione per scollegare l'apparecchiatura. Tirare sempre dalla spina.
- Servirsi unicamente di dispositivi di isolamento adeguati: interruttori automatici, fusibili (quelli a tappo devono essere rimossi dal portafusibile), sganciatori per correnti di guasto a terra e relè.
- L'impianto elettrico deve essere dotato di un dispositivo di isolamento che consenta di scollegare l'apparecchiatura dalla presa di corrente a tutti i poli. Il dispositivo di isolamento deve avere una larghezza dell'apertura di contatto non inferiore ai 3 mm.
- La dotazione standard dell'apparecchiatura al momento della fornitura prevede una spina e un cavo di rete.

2.3 Utilizzo:



AVVERTENZA!

Rischio di lesioni, ustioni, scosse elettriche o esplosioni.

- Non modificare le specifiche tecniche dell'apparecchiatura.
- Assicurarsi che le aperture di ventilazione non siano bloccate.
- Non lasciare l'elettrodomestico incustodito durante il funzionamento.
- Spegnerne l'elettrodomestico dopo ogni utilizzo.
- Prestare attenzione in fase di apertura dello sportello dell'elettrodomestico, quando quest'ultimo è in funzione. Può esservi un rilascio di aria calda.
- Non accendere l'elettrodomestico con le mani bagnate o quando è a contatto con l'acqua.
- Non esercitare pressione sullo sportello aperto.
- Non utilizzare l'elettrodomestico come superficie di lavoro o come superficie di deposito.
- Aprire lo sportello dell'elettrodomestico attentamente. L'utilizzo di ingredienti con alcol può provocare una miscela di alcol e aria.
- Non lasciare scintille o fiamme libere a contatto con l'elettrodomestico quando si apre lo sportello.
- Non appoggiare o tenere liquidi o materiali infiammabili, né oggetti facilmente infiammabili sull'apparecchiatura, al suo interno o nelle immediate vicinanze.



AVVERTENZA!

Vi è il rischio di danneggiare l'apparecchiatura.

- Per evitare danni o lo scolorimento dello smalto:
 - Non collocare pirofile o altri oggetti all'interno dell'elettrodomestico direttamente sul fondo.

- Non collocare la pellicola di alluminio direttamente sul fondo della cavità dell'elettrodomestico.
- Non versare acqua direttamente all'interno dell'elettrodomestico caldo.
- Non conservare piatti e alimenti umidi all'interno dell'elettrodomestico dopo aver terminato la cottura.
- Prestare attenzione in fase di rimozione o installazione degli accessori.
- Lo scolorimento dello smalto o dell'acciaio inox non influisce sulle prestazioni dell'elettrodomestico.
- Usare una leccarda per torte umide. I succhi di frutta causano macchie che possono essere permanenti.
- Eseguire sempre la cottura con lo sportello dell'apparecchiatura chiuso.

2.4 Pulizia e cura



AVVERTENZA!

Vi è il rischio di lesioni, incendio o danni all'apparecchiatura.

- Prima di eseguire qualunque intervento di manutenzione, spegnere l'apparecchiatura ed estrarre la spina dalla presa.
- Controllare che l'apparecchiatura sia fredda. Vi è il rischio che i pannelli in vetro si rompano.
- Sostituire immediatamente i pannelli in vetro della porta nel caso in cui siano danneggiati. Contattare il Centro Assistenza Autorizzato.
- Prestare attenzione quando si rimuove la porta dall'apparecchio. La porta è pesante!
- Pulire regolarmente l'apparecchiatura per evitare il deterioramento dei materiali che compongono la superficie.
- Pulire l'apparecchiatura con un panno inumidito e morbido. Utilizzare solo detergenti neutri. Non usare prodotti abrasivi, spugnette abrasive, solventi od oggetti metallici.
- Se si utilizza uno spray per il forno, seguire attentamente le istruzioni di sicurezza sulla confezione.

2.5 Illuminazione interna



AVVERTENZA!

Pericolo di scosse elettriche.

- Per quanto riguarda la lampada o le lampade all'interno di questo prodotto e le lampade di ricambio vendute separatamente: Queste lampade sono destinate a resistere a condizioni fisiche estreme negli elettrodomestici, come temperatura, vibrazioni, umidità, o sono destinate a segnalare informazioni sullo stato operativo dell'apparecchio. Non sono destinate ad essere utilizzate in altre applicazioni e non sono adatte per l'illuminazione di ambienti domestici.
- Questo prodotto contiene una sorgente luminosa di classe di efficienza energetica G.
- Servirsi unicamente di lampadine con le stesse specifiche tecniche .

2.6 Assistenza

- Per far riparare l'apparecchiatura, rivolgersi a un Centro di Assistenza Autorizzato.
- Utilizzare solo ricambi originali.

DESCRIZIONE DEL PRODOTTO

2.7 Smaltimento



AVVERTENZA!

Rischio di lesioni o soffocamento.

- Contattare le autorità locali per ricevere informazioni su come smaltire correttamente l'apparecchiatura.
- Staccare la spina dall'alimentazione elettrica.
- Tagliare il cavo elettrico dell'apparecchiatura e smaltirlo.
- Togliere il blocco porta per evitare che bambini, o animali restino intrappolati nell'apparecchiatura.

3. DESCRIZIONE DEL PRODOTTO

3.1 Panoramica generale

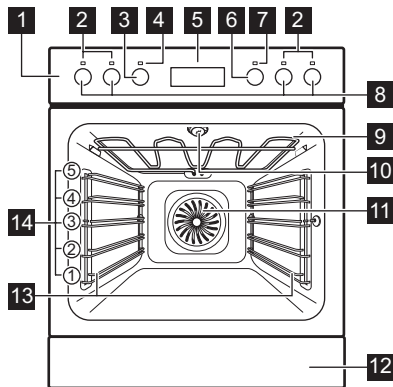

- 1** Pannello dei comandi
- 2** Spie/simboli zone di cottura
- 3** Manopola di regolazione delle funzioni cottura
- 4** Spia/simbolo alimentazione
- 5** Display
- 6** Manopola di regolazione
- 7** Indicatore/simbolo della temperatura
- 8** Manopole delle zone di cottura
- 9** Resistenza
- 10** Lampadina
- 11** Ventola
- 12** Cassetto
- 13** Supporto ripiano, rimovibile
- 14** Posizioni ripiano

3.2 Accessori

Ripiano a filo

Per stoviglie, stampi per dolci, arrosti.

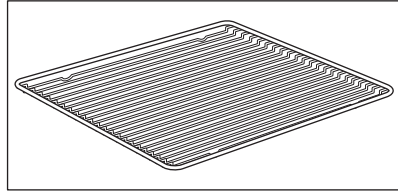

Lamiera dolci

Per torte e biscotti.

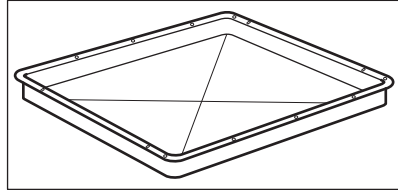

4. PANNELLO DEI COMANDI

4.1 Manopola incassabile

Per utilizzare l'apparecchiatura, premere la manopola. La manopola fuoriesce.

4.2 Manopole delle zone di cottura



AVVERTENZA!

Fare riferimento ai capitoli sulla Sicurezza nel libretto di istruzioni del piano cottura.

È possibile mettere in funzione il piano di cottura usando le manopole per le zone di cottura.

4.3 Livelli di potenza

Indicazione manopola	Funzione
0	Posizione spento
	Impostazione Mantieni caldo
1 - 9	Livelli di potenza
	Interruttore Zona doppia

Ruotare la manopola per regolare un'impostazione del calore.

PANNELLO DEI COMANDI

4.4 Utilizzo della zona doppia (se presente)

i Per attivare la zona doppia, ruotare la manopola in senso orario. Non farla passare per la posizione di arresto.

1. Ruotare la manopola in senso orario fino alla posizione 9.
2. Ruotare la manopola lentamente verso il simbolo ☉ fino a sentire un clic. Le due zone di cottura sono accese.
3. Per impostare il livello di potenza desiderato, fare riferimento a "Livelli di potenza".



4.5 Tasti sensore pannello dei comandi

				OK		
Timer	Riscaldamento rapido	Luce forno	Blocco	Confermare l'impostazione	Premere	Ruotare la manopola

Selezionare una funzione cottura per accendere il forno.

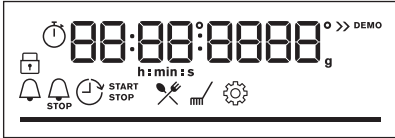
Per spegnere il forno, ruotare la manopola delle funzioni di riscaldamento fino a portarla in posizione off.

	Display con le funzioni chiave.
--	---------------------------------

Spie di-play:	 Blocco	 Cottura guidata	 Impostazioni	 Riscaldamento rapido
Spie timer:		 STOP		

Barra di avanzamento - per temperatura o tempo. Quando il forno raggiunge la temperatura impostata, la barra è completamente rossa.



5. PRIMA DEL PRIMO UTILIZZO



AVVERTENZA!

Fare riferimento ai capitoli sulla sicurezza.

5.1 Pulizia iniziale

Prima della messa in uso, pulire il forno vuoto e impostare l'ora:



00:00

Impostare l'ora. Premere OK.

5.2 Preriscaldamento iniziale



Preriscaldare il forno vuoto prima di utilizzarlo per la prima volta.

Fase 1

Togliere gli accessori e i supporti ripiano amovibili dal forno.

Fase 2

Impostare la temperatura massima per la funzione: .
Lasciare in funzione il forno per un'ora.

Fase 3

Impostare la temperatura massima per la funzione: .
Lasciare in funzione il forno per 15 minuti.



Il forno può produrre un odore sgradevole e fumo in fase di pre-riscaldamento. Accertarsi che la stanza sia ventilata.

6. UTILIZZO QUOTIDIANO





AVVERTENZA!

Fare riferimento ai capitoli sulla sicurezza.

6.1 Come impostare: Funzioni cottura





Passaggio 1





Passaggio 2

	
<p>Selezionare una funzione cottura.</p>	<p>Impostare la temperatura. Premere OK.</p>
<p> - tenere premuto per attivare la funzione: Riscaldamento rapido. È disponibile per alcune funzioni del forno.</p>	

6.2 Funzioni cottura

Funzioni cottura standard

Funzione cottura	Applicazione
 <p>Cottura ventilata</p>	<p>Per cuocere su massimo tre posizioni della griglia contemporaneamente ed essiccare i cibi. Impostare la temperatura di 20 - 40°C inferiore rispetto a Cottura convenzionale. .</p>
 <p>Cottura convenzionale</p>	<p>Per cuocere e arrostitire alimenti su una sola posizione del ripiano.</p>
 <p>Cibi congelati</p>	<p>Per rendere croccanti i cibi confezionati, come ad esempio patatine fritte, crocchette o involtini primavera.</p>
 <p>Funzione Pizza</p>	<p>Per cuocere la pizza. Per una doratura intensa e una base croccante.</p>
 <p>Resistenza inferiore</p>	<p>Per dorare torte con base croccante e per conservare gli alimenti.</p>

Funzione cottura	Applicazione
 Scongelamento	Per scongelare gli alimenti (verdura e frutta). Il tempo di scongelamento dipende dalla quantità e dalle dimensioni del cibo congelato.
 Cottura ventilata umida	Questa funzione è progettata per il risparmio energetico durante la cottura. Quando viene usata questa funzione, la temperatura all'interno della cavità potrebbe essere diversa rispetto alla temperatura impostata. Viene utilizzato il calore residuo. La potenza riscaldante potrebbe essere ridotta. Per ulteriori informazioni, consultare il capitolo "Uso quotidiano", Note su: Cottura ventilata umida.
 Grill	Per grigliare alimenti di ridotto spessore e tostare il pane.
 Doppio grill ventilato	Per arrostitire grandi tagli di carne o pollame con ossa su una posizione della griglia. Per gratinare e dorare.
 Menu	Per accedere al Menu: Cottura guidata, Pulizia, Impostazioni.

6.3 Note su: Cottura ventilata umida

Questa funzione è stata utilizzata per la conformità alla classe energetica e ai requisiti di ecodesign (secondo la normativa UE 65/2014 e UE 66/2014). Test conformemente a: IEC/EN 60350-1

La porta del forno dovrebbe essere chiusa in fase di cottura, in modo che la funzione non venga interrotta. Ciò garantisce inoltre che il forno funzioni con la più elevata efficienza energetica possibile.







Quando viene usata questa funzione, la lampada si spegne automaticamente dopo 30 secondi. Per le istruzioni di cottura rimandiamo al capitolo "Consigli e suggerimenti", Cottura ventilata umida. Per indicazioni generali sul risparmio energetico rimandiamo al capitolo "Efficienza energetica", Risparmio energetico.

6.4 Come impostare: Cottura guidata



Ogni pietanza di questo sottomenu prevede funzione e temperatura consigliate. È possibile regolare l'ora e la temperatura in fase di cottura.

Alcune pietanze possono anche essere cucinate usando:	<ul style="list-style-type: none"> • Peso automatico
---	---





Cottura guidata - utilizzare per preparare un piatto rapidamente con le impostazioni predefinite:











Passaggio 1	Passaggio 2	Passaggio 3	Passaggio 4
 	 	 P1 - P45	 OK
Accedere al menu.	Selezionare Cottura guidata. Premere OK .	Selezionare la pietanza. Premere OK .	Inserire la pietanza nel forno. Confermare l'impostazione.

6.5 Cottura guidata













Legenda	
	Peso automatico disponibile.
	Preriscaldare il forno prima di iniziare a cucinare.
	Livello del ripiano.





















Al termine della funzione, controllare se il cibo è pronto.

	Piatto	Peso	Livello / Accessorio ripiano	Durata
Manzo 				
P1	Roast beef, al sangue	1 - 1,5 kg; pezzi spessi 4-5 cm	 2 lamiera dolci Friggere la carne per alcuni minuti in una padella calda. Informare.	40 min
P2	Roast beef, cottura media			50 min
P3	Roast beef, ben cotto			60 min
P4	Bistecca, media cottura	180 - 220 g per pezzo; fette di 3 cm di spessore	  3; pirofila su ripiano a filo Friggere la carne per alcuni minuti in una padella calda. Informare.	15 min

















	Piatto	Peso	Livello / Accessorio ripiano	Durata
P5	Arrosto di manzo / brasato (costoletta, scamone, fesa)	1,5 - 2 kg	  2; pirofila su ripiano a filo Friggere la carne per alcuni minuti in una padella calda. Aggiungere liquido. Infornare.	120 min
P6	Roast beef, al sangue (cottura lenta)	1 - 1,5 kg; pezzi spessi 4-5 cm	 2; lamiera dolci Utilizzare le spezie preferite o il semplice pepe macinato. Friggere la carne per alcuni minuti in una padella calda. Infornare.	75 min
P7	Roast beef, cottura media (cottura lenta)			85 min
P8	Roast beef, ben cotto (cottura lenta)			130 min
P9	Filetto, al sangue (cottura lenta)	0,5 - 1,5 kg; pezzi spessi 5-6 cm	 2 lamiera dolci Utilizzare le spezie preferite o il semplice pepe macinato. Friggere la carne per alcuni minuti in una padella calda. Infornare.	75 min
P10	Filetto, cottura media (cottura lenta)			90 min
P11	Filetto, cotto (cottura lenta)			120 min
Vitello 				
P12	Arrosto di vitello (ad es. spalla)	0,8 - 1,5 kg; pezzi spessi 4 cm	  2; pirofila su ripiano a filo Utilizzare le spezie preferite. Aggiungere liquido. Arrosto coperto.	80 min
Maiale  				
P13	Collo o spalla di maiale arrosto	1,5 - 2 kg	  2; pirofila su ripiano a filo Girare la carne a metà cottura.	120 min







UTILIZZO QUOTIDIANO

	Piatto	Peso	Livello / Accessorio ripiano	Durata
P14	Maiale sfilacciato (cottura lenta)	1,5 - 2 kg	 2 lamiera dolci Utilizzare le spezie preferite. Girare la carne a metà cottura per ottenere una doratura uniforme.	215 min
P15	Lombo, fresco	1 - 1,5 kg; pezzi spessi 5-6 cm	 2 ; pirofila su ripiano a filo Utilizzare le spezie preferite.	55 min
P16	Costolette di maiale	2 - 3 kg; utilizzare puntine crude, 2 - 3 cm	 3; leccarda Aggiungere il liquido per coprire il fondo di un piatto. Girare la carne a metà cottura.	90 min
Agnello 				
P17	Cosciotto d'agnello con ossa	1,5 - 2 kg; 7 - 9 cm di spessore	 2 ; pirofila su lamiera dolci Aggiungere liquido. Girare la carne a metà cottura.	130 min
Pollame 				
P18	Pollo intero	1 - 1,5 kg; fresco	  2 casseruola su lamiera dolci Utilizzare le spezie preferite. Girare il pollo a metà cottura per ottenere una doratura uniforme.	60 min
P19	Mezzo pollo	0,5 - 0,8 kg	 3; teglia da forno Utilizzare le spezie preferite.	40 min
P20	Pollo, petto	180 - 200 g per pezzo	  2 ; casseruola su ripiano a filo Utilizzare le spezie preferite. Friggere la carne per alcuni minuti in una padella calda.	25 min
P21	Cosce di pollo, fresche	-	 3; lamiera dolci Se le cosce di pollo sono state marinate prima, impostare la temperatura più bassa e cuocerle più a lungo.	30 min

	Piatto	Peso	Livello / Accessorio ripiano	Durata
P22	Anatra, intera	2 - 3 kg	  2; pirofila su ripiano a filo Utilizzare le spezie preferite. Sistemare la carne sulla teglia. Girare l'anatra a metà cottura.	100 min
P23	Oca, intera	4 - 5 kg	  2; leccarda Utilizzare le spezie preferite. Sistemare la carne su una teglia da forno profonda. Girare l'oca a metà cottura.	110 min
Altro 				
P24	Polpettone	1 kg	 2; ripiano a filo Utilizzare le spezie preferite.	60 min
Pesce 				
P25	Pesce intero, grigliato	0,5 - 1 kg per pesce	 2 lamiera dolci Farcire il pesce con burro e utilizzare spezie ed erbe preferite.	30 min
P26	Filetto di pesce	-	  3; casseruola su ripiano a filo Utilizzare le spezie preferite.	20 min
Dolci da forno / dessert   				
P27	Cheesecake	-	 2;  Tortiera apribile da 28 cm su ripiano a filo	90 min
P28	Torta di mele	-	 3; lamiera dolci	45 min
P29	Crostata di mele	-	 2; tortiera su ripiano a filo	40 min
P30	Torta di mele americana	-	 1;  tortiera da 22 cm su ripiano a filo	60 min
P31	Brownies	2 kg	 3 leccarda	30 min





UTILIZZO QUOTIDIANO

	Piatto	Peso	Livello / Accessorio ripiano	Durata
P32	Muffin al cioccolato	-	 3, vassoio muffin su ripiano a filo	25 min
P33	Torta di pane	-	 2; leccarda su ripiano a filo	50 min
Verdure / Contorni   				
P34	Patate al forno	1 kg	 2; lamiera dolci Mettere le patate intere con buccia sulla lamiera dolci.	50 min
P35	Spicchi	1 kg	 3 lamiera dolci rivestita con carta da forno Utilizzare le spezie preferite. Tagliare le patate a pezzi.	35 min
P36	Verdure miste grigliate	1 - 1,5 kg	 3 lamiera dolci rivestita con carta da forno Utilizzare le spezie preferite. Tagliare le verdure a pezzi.	30 min
P37	Crocchette, surgelate	0,5 kg	 3; lamiera dolci	25 min
P38	Patatine, surgelate	0,75 kg	 3; lamiera dolci	25 min
Gratin, pane e pizza   				
P39	Lasagne di carne/verdure con piatti di pastasciutta	1 - 1,5 kg	 2 casseruola su ripiano a filo	45 min
P40	Patate gratinate (patate crude)	1 - 1,5 kg	 1 casseruola su ripiano a filo Ruotare il piatto a metà del tempo di cottura.	50 min
P41	Pizza fresca, sottile	-	  2 lamiera dolci rivestita con carta da forno	15 min

	Piatto	Peso	Livello / Accessorio ripiano	Durata
P42	Pizza fresca, spessa	-	  2; lamiera dolci rivestita con carta da forno	25 min
P43	Quiche	-	 2; teglia da forno su ripiano a filo	45 min
P44	Baguette / Ciabatta / Pane bianco	0,8 kg	  3 lamiera dolci rivestita con carta da forno Più tempo necessario per il pane bianco.	30 min
P45	Impasto per pane integrale / pane di segale /pane nero in uno stampo per pane	1 kg	  2; lamiera dolci rivestita con carta da forno/ ripiano a filo	60 min

7. FUNZIONI DEL TIMER

7.1 Funzioni orologio

Funzione Orologio	Applicazione
	Contaminuti. Allo scadere del tempo, viene emesso un segnale acustico.
	Tempo di cottura. Quando il timer arriva alla fine, si sente un segnale e la funzione cottura si ferma.
	Ritardo. Per posticipare l'inizio e/o la fine della cottura.
	Timer. Il massimo è 23 ore 59 min. Questa funzione non ha nessun effetto sul funzionamento del forno. Per accendere e spegnere Timer selezionare: Menu, Impostazioni.

7.2 Come impostare: Funzioni Orologio





Come impostare: Imposta ora		
Passaggio 1	Passaggio 2	Passaggio 3

FUNZIONI DEL TIMER

Come impostare: Imposta ora



		
Per modificare l'ora, accedere al menu e selezionare Impostazioni, Ora.	Impostare l'orologio.	Premere: OK.

Come impostare: Contaminuti

Passaggio 1	Il display visualizza: 0:00 	Passaggio 2	Passaggio 3
			
Premere:  .		Imposta Contaminuti	Premere: OK.









i Il timer inizia subito il conto alla rovescia.

Come impostare: Tempo di cottura

Passaggio 1	Passaggio 2	Il display visualizza: 0:00  STOP	Passaggio 3	Passaggio 4
				
Selezionare una funzione di cottura e impostare la temperatura.	Premere ripetutamente:  .		Impostare la durata della cottura.	Premere: OK.

i Il timer inizia subito il conto alla rovescia.

Come impostare: Ritardo

Passaggio 1	Passaggio 2		Passaggio 3	Passaggio 4		Passaggio 5	Passaggio 6
		Il display mostra: l'ora del giorno  START			Il display visualizza: --:--  STOP		
Selezionare la funzione riscaldamento.	Premere ripetutamente: 		Impostare l'orario di inizio.	Premere: OK.		Impostare l'orario di fine.	Premere: OK.

 Il timer inizia il conto alla rovescia a un orario di inizio impostato.

8. COME USARE: ACCESSORI

8.1 Inserimento di accessori

Un piccolo rientro sulla parte superiore aumenta il livello di sicurezza. Gli incavi sono anche dispositivi antiribaltamento. Il bordo alto intorno al ripiano evita che pentole e padelle scivolino dal ripiano.

Ripiano a filo:

Spingere il ripiano fra le guide del supporto.

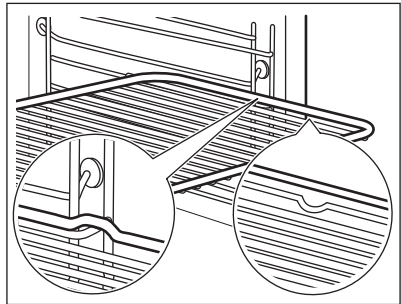

Lamiera dolci:

Spingere la lamiera tra le guide del supporto ripiano.

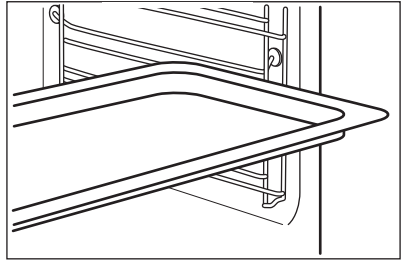

9. FUNZIONI AGGIUNTIVE

9.1 Blocco

Questa funzione evita che si cambi per sbaglio la funzione dell'apparecchiatura.

Attivarla quando l'apparecchiatura è in funzione: la cottura impostata continua, il pannello dei comandi è bloccato.

Attivarla quando l'apparecchiatura è spenta - l'apparecchiatura non può essere accesa, il pannello dei comandi è bloccato.



- tenere premuto per attivare la funzione.
Viene emesso un segnale acustico.





- premere e tenere premuto per disattivarla.

 3 x  - lampeggia quando il blocco è attivato.

9.2 Spegnimento automatico

Per ragioni di sicurezza, il forno si spegne dopo un determinato periodo di tempo se è attiva una funzione di riscaldamento e non si modificano le impostazioni.

 (°C)	 (ora)
30 - 115	12.5
120 - 195	8.5
200 - 245	5.5
250 - massimo	3

Lo spegnimento automatico non funziona con le funzioni: Luce forno, Ritardo.



9.3 Ventola di raffreddamento

Quando l'apparecchiatura è in funzione, la ventola di raffreddamento si attiva in modo automatico per raffreddare le superfici. Dopo aver spento l'apparecchiatura, la ventola di raffreddamento continua a funzionare finché l'apparecchiatura non si è raffreddata.

10. CONSIGLI E SUGGERIMENTI UTILI

10.1 Cottura ventilata umida



Per ottenere i risultati migliori, attenersi ai suggerimenti elencati nella tabella sottostante. Utilizzare la posizione del terzo ripiano.

	 (°C)	 (min.)
Pasta gratinata	200 - 220	45 - 55
Patate gratinate	180 - 200	70 - 85
Moussaka	170 - 190	70 - 95
Lasagne	180 - 200	75 - 90
Cannelloni	180 - 200	70 - 85
Budino di pane	190 - 200	55 - 70
Budino di riso	170 - 190	45 - 60
Torta di mele, preparata con miscela per pan di Spagna (stampo per dolci rotondo)	160 - 170	70 - 80
Pane bianco	190 - 200	55 - 70

10.2 Cottura ventilata umida - accessori consigliati

Usare scatole e contenitori scuri e non riflettenti. Assorbono meglio il calore rispetto al colore chiaro e ai piatti riflettenti.

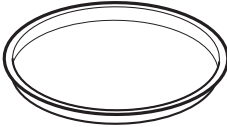
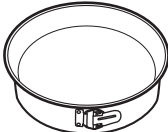

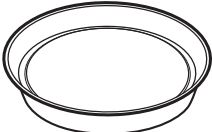



CONSIGLI E SUGGERIMENTI UTILI

			
Teglia da pizza	Pirofila	Pirofile monoporzione	Tortiera per flan
Scura, non riflettente 28 cm di diametro	Scura, non riflettente 26 cm di diametro	Ceramica diametro 8 cm, altezza 5 cm	Scura, non riflettente 28 cm di diametro

10.3 Tabelle di cottura per gli istituti di test

Informazioni per gli istituti di prova

Test conformemente a: EN 60350, IEC 60350.

 COTTURA SU UN LIVELLO Cottura in stampi				
		 (°C)	 (min)	
Pan di Spagna senza grassi	Cottura ventilata	140 - 150	35 - 50	2
Pan di Spagna senza grassi	Cottura convenzionale	160	35 - 50	2
Torta di mele americana, 2 stampi Ø20 cm	Cottura ventilata	160	60 - 90	2
Torta di mele americana, 2 stampi Ø20 cm	Cottura convenzionale	180	70 - 90	1





CONSIGLI E SUGGERIMENTI UTILI



COTTURA SU UN LIVELLO Biscotti







Utilizzare la posizione del terzo ripiano.

		 (°C)	 (min)
Frollini al burro / Strisce di pasta	Cottura ventilata	140	25 - 40
Frollini al burro / Strisce di pasta, preriscaldare il forno vuoto	Cottura convenzionale	160	20 - 30
Tortine, 20 per teglia, preriscaldare il forno vuoto	Cottura ventilata	150	20 - 35
Tortine, 20 per teglia, preriscaldare il forno vuoto	Cottura convenzionale	170	20 - 30



COTTURA MULTILIVELLO. Biscotti

		 (°C)	 (min)	
Frollini al burro / Strisce di pasta	Cottura ventilata	140	25 - 45	1 / 4
Tortine, 20 per teglia, preriscaldare il forno vuoto	Cottura ventilata	150	23 - 40	1 / 4
Pan di Spagna senza grassi	Cottura ventilata	160	35 - 50	1 / 4

PULIZIA E CURA



Preriscaldare il forno vuoto per 5 minuti.



Grigliare con l'impostazione di temperatura massima.



(min)



Toast

Grill

1 - 3

5

Manzo, bistecca, girare il piatto a metà cottura

Grill

24 - 30

4

11. PULIZIA E CURA



AVVERTENZA!

Fare riferimento ai capitoli sulla sicurezza.

11.1 Note sulla pulizia



Agenti di pulizia

Pulire la parte anteriore dell'apparecchiatura solo con un panno in microfibra imbevuto di acqua tiepida e detergente delicato.

Servirsi di una soluzione detergente per pulire le superfici metalliche.

Pulire le macchie con un detergente delicato.



Uso quotidiano

Pulire la cavità dopo ogni utilizzo. L'accumulo di grasso o di altri residui potrebbe causare un incendio.

Non lasciare le vivande nell'apparecchiatura per più di 20 minuti. Asciugare la cavità dopo ogni utilizzo solo con un panno in microfibra.

 <p>Accessori</p>	<p>Pulire tutti gli accessori dopo ogni utilizzo e lasciarli asciugare. Utilizzare solo un panno in microfibra imbevuto di acqua tiepida e un detergente delicato. Non pulire gli accessori in lavastoviglie.</p>
	<p>Non pulire gli accessori anti-aderenti con agenti abrasivi o oggetti appuntiti.</p>

11.2 Come rimuovere: Supporti del ripiano

Rimuovere i supporti ripiano per pulire il forno.

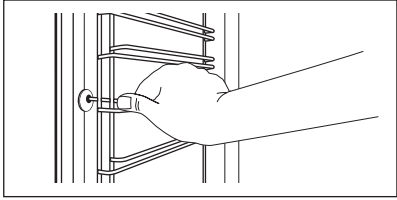
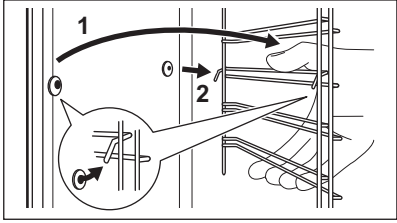
<p>Pas-saggio 1</p>	<p>Spegner il forno e attendere che si raffreddi.</p>	
<p>Pas-saggio 2</p>	<p>Sfilare dapprima la guida di estrazione dalla parete laterale tirandola in avanti.</p>	
<p>Pas-saggio 3</p>	<p>Estrarre la parte posteriore del supporto ripiano dalla parete laterale e rimuoverla.</p>	
<p>Pas-saggio 4</p>	<p>Installare i supporti ripiani seguendo al contrario la procedura indicata.</p>	

11.3 Come togliere: Grill

	<p>AVVERTENZA! Pericolo di ustione.</p>
--	--

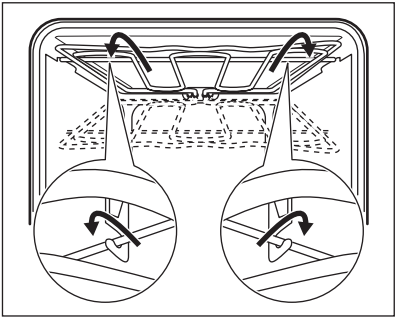
Fase 1	Spegner il forno e attendere che sia freddo per pulirlo. Rimuovere i supporti ripiano.	
Fase 2	Tirarlo in avanti contro la molla a pressione ed estrarlo dai due supporti. La griglia si piega.	
Fase 3	Pulire la parte superiore del forno con acqua tiepida, un panno morbido e detergente delicato. Lasciare asciugare.	
Fase 4	Installare la griglia seguendo al contrario la procedura indicata.	
Fase 5	Montare i supporti ripiano.	

11.4 Procedura di rimozione e installazione: Porta

È possibile rimuovere la porta e i pannelli in vetro interni per procedere alle operazioni di pulizia. Il numero di pannelli di vetro varia a seconda dei modelli.



AVVERTENZA!

La porta è pesante.



ATTENZIONE!

Maneggiare con cura il vetro, in particolare intorno ai bordi del pannello frontale. Il vetro può rompersi.

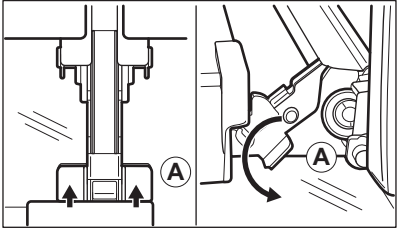
Pas-saggio 1	Aprire completamente la porta.	
Pas-saggio 2	Sollevarre e premere le leve di serraggio (A) sulle due cerniere.	
Pas-saggio 3	Chiudere la porta del forno fino alla prima posizione di apertura (un angolo di circa 70°). Afferrare la porta su entrambi i lati e tirarla fino ad allontanarla dal forno mantenendo un'inclinazione verso l'alto. Poggiare la porta con il lato esterno rivolto verso il basso su un panno morbido su una superficie stabile.	

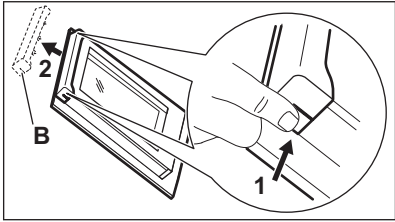
Pas-saggio 4	Tenere il rivestimento della porta (B) sul bordo superiore della porta da entrambi i lati e spingere verso l'interno per sbloccare la guarnizione a clip.	
Pas-saggio 5	Rimuovere il rivestimento tirandolo in avanti.	
Pas-saggio 6	Afferrare uno ad uno i pannelli di vetro della porta dal bordo superiore e estrarli dalla guida.	
Pas-saggio 7	Pulire il pannello in vetro con acqua e sapone. Asciugare con cura il pannello in vetro. Non pulire i pannelli in vetro in lavastoviglie.	
Pas-saggio 8	Dopo la pulizia, eseguire i passaggi di cui sopra nella sequenza opposta.	
Pas-saggio 9	Installare per primo il pannello più piccolo, poi quello più grande e la porta. Verificare che i pannelli in vetro vengano inseriti nella posizione corretta, altrimenti la superficie della porta potrebbe surriscaldarsi.	

11.5 Come sostituire: Lampadina



AVVERTENZA!

Pericolo di scosse elettriche.
La lampada potrebbe essere calda.

Prima di sostituire la lampadina:

Passaggio 1	Passaggio 2	Passaggio 3
Spegnerne il forno. Attendere che il forno sia freddo.	Estrarre la spina dalla presa di corrente.	Appoggiare un panno sul fondo della cavità.

RISOLUZIONE DEI PROBLEMI

Lampadina superiore

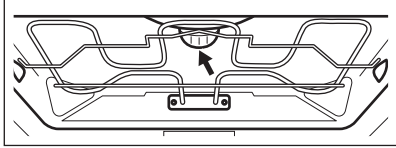
Pas-saggio 1	Girare il rivestimento di vetro per toglierlo.	
Pas-saggio 2	Pulire il coperchio in vetro.	
Pas-saggio 3	Sostituire la lampadina con una adatta, alogena, termoresistente fino a 300°C, 230 V, 40 W.	
Pas-saggio 4	Installare il coperchio in vetro.	

12. RISOLUZIONE DEI PROBLEMI



AVVERTENZA!

Fare riferimento ai capitoli sulla sicurezza.

12.1 Cosa fare se...

Per tutti i casi non inclusi in questa tabella si prega di contattare un Centro di assistenza autorizzato.



Il forno non si accende o non riscalda

Problema	Controllare se...
Non è possibile attivare il forno o metterlo in funzione.	Il forno è stato collegato correttamente all'alimentazione di rete.
Il forno non scalda.	Lo spegnimento automatico è disattivo.
Il forno non scalda.	È saltato il fusibile.
Il forno non scalda.	Il blocco è disattivato.

 Componenti	
Problema	Controllare se...
La spia è spenta.	Cottura ventilata umida - è acceso.
La lampadina non funziona.	La lampadina è bruciata.

 Codici di errore	
Il display visualizza...	Controllare se...
00:00	Si è verificata un'interruzione dell'alimentazione elettrica. Impostare l'ora.
Il display mostra un codice di errore non presente nella tabella. Disattivare e riattivare il fusibile domestico e riavviare il forno. In caso di ricomparsa del codice di errore, contattare il Centro di assistenza autorizzato.	

12.2 Dati dell'Assistenza

Qualora non sia possibile trovare una soluzione al problema, contattare il rivenditore o un Centro di assistenza autorizzato.

Le informazioni necessarie per il Centro Assistenza si trovano sulla targhetta dei dati. La targhetta si trova sul telaio anteriore della cavità dell'apparecchiatura. Non rimuovere la targhetta dei dati dalla cavità dell'apparecchiatura.

Consigliamo di annotare i dati qui:	
Modello (Mod.)
Codice prodotto (PNC)
Numero di serie (S.N.)

13. EFFICIENZA ENERGETICA

13.1 Informazioni sul prodotto e scheda informativa sul prodotto

Nome del fornitore	Electrolux
--------------------	------------

Identificazione modello	EH7L4CN 948533595 EH7L4SW 948533596 EH7L4WE 948533597	
Indice di efficienza energetica	81.2	
Classe di efficienza energetica	A+	
Consumo energetico con carico standard, modalità tradizionale	1.09 kWh/ciclo	
Consumo di energia con un carico standard, modalità a circolazione d'aria forzata	0.69 kWh/ciclo	
Numero di cavità	1	
Fonte di calore	Elettricità	
Volume	71 l	
Tipo di forno	Forno da incasso inferiore	
Massa	EH7L4CN	39.0 kg
	EH7L4SW	39.0 kg
	EH7L4WE	39.0 kg

IEC/EN 60350-1 - Apparecchiature elettriche per la cottura per uso domestico - Parte 1: Cucine, forni, forni a vapore e griglie - Metodi per la misura delle prestazioni.

13.2 Risparmio energetico



L'apparecchiatura ha di funzioni che consentono di aiutarvi a risparmiare energia durante le operazioni di cottura di tutti i giorni.

Assicurarsi che la porta dell'apparecchiatura sia chiusa quando l'apparecchiatura è in funzione. Non aprire troppo spesso la porta durante la cottura. Tenere pulita la guarnizione della porta e assicurarsi che sia ben fissata nella posizione corretta.

Servirsi di pentole in metallo per migliorare il risparmio energetico .

Ove possibile, non pre-riscaldare l'apparecchiatura prima della cottura.

Ridurre quanto più possibile gli intervalli fra le diverse operazioni di cottura quando vengono preparati più piatti contemporaneamente.

Cucinare con ventola

Ove possibile, servirsi delle funzioni di cottura con la ventola per risparmiare energia.

Calore residuo

La ventola e la lampada continuano a funzionare. Quando si spegne l'apparecchiatura, il display visualizza il calore residuo. Si può usare quel calore per mantenere le pietanze in caldo.

Quando la durata di cottura è superiore ai 30 minuti, ridurre la temperatura dell'apparecchiatura al minimo 3-10 minuti prima della fine del processo di cottura. La cottura proseguirà grazie al calore residuo all'interno dell'apparecchiatura.

Utilizzare il calore residuo per scaldare altri piatti.

Tenere in caldo gli alimenti

Scegliere l'impostazione di temperatura più bassa per sfruttare il calore residuo e mantenere calda la pietanza. La spia di calore residuo o la temperatura compaiono sul display.

Cottura con lampada spenta

Spegnere la lampada in fase di cottura. Accenderla solo quando è necessario.

Cottura ventilata umida



Funzione progettata per risparmiare energia in fase di cottura.



Quando si utilizza questa funzione, la lampadina si spegne automaticamente dopo 30 secondi.







È possibile riaccendere la lampada, ma questa azione ridurrà i risparmi energetici previsti.

14. STRUTTURA DEL MENU

14.1 Menu

	 - selezionare per accedere alla Menu.
---	---

Menu struttura	
Cottura guidata 	Impostazioni 

Passaggio 1	Passaggio 2	Passaggio 3	Passaggio 4	Passaggio 5
 	 OK	 O1 - 10	 OK	
Selezionare il Menu, Impostazioni.	Confermare l'impostazione.	Selezionare l'impostazione.	Confermare l'impostazione.	Regolare il valore e premere OK.

Impostazioni					
O1	Imposta ora	Modifica	O2	Luminosità	1 - 5

STRUTTURA DEL MENU

Impostazioni					
O3	Volume toni	1 - Bip 2 - Fare clic 3 - Segnale acustico spento	O4	Volume acustico	1 - 4
O5	Timer	On/Off	O6	Luce forno	On/Off
O7	Riscaldamento rapido	On/Off	O8	Modalità demo	Codice di attivazione: 2468
O9	Versione software	Controllare	O10	Ripristino impostazioni iniziali di fabbrica	Sì / No

15. GARANZIA

Servizio clienti

Servizio dopo vendita		
Industriestrasse 10 5506 Mägenwil	Le Trézi 6 1028 Prévèrenge	Via Violino 11 6928 Manno
Morgenstrasse 131 3018 Bern	 <p>Service-Helpline 0848 848 111 service@electrolux.ch</p>	
Langgasse 10 9008 St. Gallen		
Am Mattenhof 4a/b 6010 Kriens		
Schlossstrasse 1 4133 Pratteln		
Comercialstrasse 19 7000 Chur		



Vendita pezzi di ricambio Industriestrasse 10, 5506 Mägenwil, Tel. 0848 848 111

Consulenza specialistica/Vendita Badenerstrasse 587, 8048 Zürich, Tel. 044 405 81 11

Garanzia Per ogni prodotto concediamo una garanzia di 2 anni a partire dalla data di consegna o dalla sua messa in funzione. (fa stato la data della fattura, del certificato di garanzia o dello scontrino d'acquisto) Nella garanzia sono comprese le spese di manodopera, di viaggio e del materiale. Dalla copertura sono esclusi il logoramento ed i danni causati da agenti esterni,

intervento di terzi, utilizzo di ricambi non originali o dalla inosservanza delle prescrizioni d'installazione ed istruzioni per l'uso.

16. CONSIDERAZIONI SULL'AMBIENTE

Riciclare i materiali con il simbolo . Buttare l'imballaggio negli appositi contenitori per il riciclaggio. Aiutare a proteggere l'ambiente e la salute umana e a riciclare rifiuti derivanti da apparecchiature elettriche ed elettroniche. Non smaltire le apparecchiature che riportano il simbolo  insieme ai normali rifiuti domestici. Portare il prodotto al punto di riciclaggio più vicino o contattare il comune di residenza.



Per la Svizzera:

Dove portare gli apparecchi fuori uso?

In qualsiasi negozio che vende apparecchi nuovi oppure si restituiscono ai centri di raccolta ufficiali della SENS oppure ai riciclatori ufficiali della SENS.

La lista dei centri di raccolta ufficiali della SENS è visibile nel sito

www.erecycling.ch

CONTENTS

WE'RE THINKING OF YOU

Thank you for purchasing an Electrolux appliance. You've chosen a product that brings with it decades of professional experience and innovation. Ingenious and stylish, it has been designed with you in mind. So whenever you use it, you can be safe in the knowledge that you'll get great results every time.

Welcome to Electrolux.

Visit our website to:



Get usage advice, brochures, trouble shooter, service and repair information:
www.electrolux.com/support



Register your product for better service:
www.registerelectrolux.com



Buy Accessories, Consumables and Original spare parts for your appliance:
www.electrolux.com/shop



For more recipes, hints, troubleshooting download **My Electrolux Kitchen** app.



CUSTOMER CARE AND SERVICE

Always use original spare parts.

When contacting our Authorised Service Centre, ensure that you have the following data available: Model, PNC, Serial Number.

The information can be found on the rating plate.

 Warning / Caution-Safety information

 General information and tips

 Environmental information

Subject to change without notice.

CONTENTS

1. SAFETY INFORMATION.....	109	2.7 Disposal.....	114
1.1 Children and vulnerable people safety.....	109	3. PRODUCT DESCRIPTION.....	115
1.2 General Safety.....	110	3.1 General overview.....	115
2. SAFETY INSTRUCTIONS.....	111	3.2 Accessories.....	115
2.1 Installation.....	111	4. CONTROL PANEL.....	116
2.2 Electrical connection.....	112	4.1 Retractable knobs.....	116
2.3 Use.....	113	4.2 Knobs for the cooking zones.....	116
2.4 Care and cleaning.....	113	4.3 Heat settings.....	116
2.5 Internal lighting.....	114	4.4 Using the double zone (if applicable).....	116
2.6 Service.....	114	4.5 Control panel sensor fields.....	117

5. BEFORE FIRST USE	117	10.2 Moist Fan Baking - recommended accessories.....	130
5.1 Initial cleaning.....	118	10.3 Cooking tables for test institutes	130
5.2 Initial preheating.....	118		
6. DAILY USE	118	11. CARE AND CLEANING	132
6.1 How to set: Heating functions.....	118	11.1 Notes on cleaning.....	132
6.2 Heating functions.....	119	11.2 How to remove: Shelf supports	133
6.3 Notes on: Moist Fan Baking.....	120	11.3 How to remove: Grill.....	133
6.4 How to set: Assisted Cooking.....	120	11.4 How to remove and install: Door	134
6.5 Assisted Cooking.....	120	11.5 How to replace: Lamp.....	135
7. CLOCK FUNCTIONS	125	12. TROUBLESHOOTING	136
7.1 Clock functions.....	125	12.1 What to do if.....	136
7.2 How to set: Clock functions.....	126	12.2 Service data.....	137
8. HOW TO USE: ACCESSORIES	127	13. ENERGY EFFICIENCY	137
8.1 Inserting accessories.....	127	13.1 Product Information and Product Information Sheet.....	137
9. ADDITIONAL FUNCTIONS	128	13.2 Energy saving.....	138
9.1 Lock.....	128	14. MENU STRUCTURE	139
9.2 Automatic switch-off.....	128	14.1 Menu.....	139
9.3 Cooling fan.....	129	15. GUARANTEE	140
10. HINTS AND TIPS	129	16. ENVIRONMENTAL CONCERNS	140
10.1 Moist Fan Baking.....	129		

1. SAFETY INFORMATION

Before the installation and use of the appliance, carefully read the supplied instructions. The manufacturer is not responsible for any injuries or damage that are the result of incorrect installation or usage. Always keep the instructions in a safe and accessible location for future reference.

1.1 Children and vulnerable people safety

- This appliance can be used by children aged from 8 years and above and persons with reduced physical, sensory or mental capabilities or lack of experience and knowledge if they have been given supervision or instruction concerning the use of the appliance in a safe way and understand the hazards involved. Children of less than 8 years of age and persons with very extensive and complex disabilities shall

be kept away from the appliance unless continuously supervised.

- Children should be supervised to ensure that they do not play with the appliance.
- Keep all packaging away from children and dispose of it appropriately.
- **WARNING:** The appliance and its accessible parts become hot during use. Keep children and pets away from the appliance when in use and when cooling down.
- If the appliance has a child safety device, it should be activated.
- Children shall not carry out cleaning and user maintenance of the appliance without supervision.

1.2 General Safety

- This appliance is for cooking purposes only.
- This appliance is designed for single household domestic use in an indoor environment.
- This appliance may be used in, offices, hotel guest rooms, bed & breakfast guest rooms, farm guest houses and other similar accommodation where such use does not exceed (average) domestic usage levels.
- Only a qualified person must install this appliance and replace the cable.
- Do not use the appliance before installing it in the built-in structure.
- Disconnect the appliance from the power supply before carrying out any maintenance.
- If the mains power supply cable is damaged, it must be replaced by the manufacturer, its Authorised Service Centre or similarly qualified persons to avoid an electrical hazard.
- The control panel must be connected to specified heating unit with matching colours of connectors, to avoid possible hazard.

- The means for disconnection must be incorporated in the fixed wiring in accordance with the wiring rules.
- **WARNING:** Ensure that the appliance is switched off before replacing the lamp to avoid the possibility of electric shock.
- **WARNING:** The appliance and its accessible parts become hot during use. Care should be taken to avoid touching heating elements or the surface of the appliance cavity.
- Always use oven gloves to remove or insert accessories or ovenware.
- To remove the shelf supports first pull the front of the shelf support and then the rear end away from the side walls. Install the shelf supports in the opposite sequence.
- Do not use a steam cleaner to clean the appliance.
- Do not use harsh abrasive cleaners or sharp metal scrapers to clean the glass door since they can scratch the surface, which may result in shattering of the glass.

2. SAFETY INSTRUCTIONS

2.1 Installation

**WARNING!**

Only a qualified person must install this appliance.

- Remove all the packaging.
- Do not install or use a damaged appliance.
- Follow the installation instructions supplied with the appliance.
- Always take care when moving the appliance as it is heavy. Always use safety gloves and enclosed footwear.
- Do not pull the appliance by the handle.
- Install the appliance in a safe and suitable place that meets installation requirements.
- The kitchen cabinet and the recess must have suitable dimensions.
- Keep the minimum distance from other appliances and units.
- Before mounting the appliance, check if the appliance door opens without restraint.
- Parts of the appliance carry current. Close the appliance with furniture to prevent touching the dangerous parts.
- The appliance is equipped with an electric cooling system. It must be operated with the electric power supply.
- The built-in unit must meet the stability requirements of DIN 68930.

SAFETY INSTRUCTIONS

Cabinet minimum height (Cabinet under the work-top minimum height)	762 (762) mm
Cabinet width	550 mm
Cabinet depth	605 (580) mm
Height of the front of the appliance	757 mm
Height of the back of the appliance	739 mm
Width of the front of the appliance	549 mm
Width of the back of the appliance	548 mm
Depth of the appliance	567 mm
Built in depth of the appliance	546 mm
Depth with open door	1017 mm
Ventilation opening minimum size. Opening placed on the bottom rear side	550 x 20 mm
Mounting screws	4x12 mm

2.2 Electrical connection



WARNING!

Risk of fire and electric shock.

- All electrical connections should be made by a qualified electrician.
- The appliance must be earthed.
- Make sure that the parameters on the rating plate are compatible with the electrical ratings of the mains power supply.
- Always use a correctly installed shockproof socket.
- Do not use multi-plug adapters and extension cables.
- Make sure not to cause damage to the mains plug and to the mains cable. Should the mains cable need to be replaced, this must be carried out by our Authorised Service Centre.
- Do not let mains cables touch or come near the appliance door or the niche below the appliance, especially when it operates or the door is hot.
- The shock protection of live and insulated parts must be fastened in such a way that it cannot be removed without tools.
- Connect the mains plug to the mains socket only at the end of the installation. Make sure that there is access to the mains plug after the installation.
- If the mains socket is loose, do not connect the mains plug.
- Do not pull the mains cable to disconnect the appliance. Always pull the mains plug.

- Use only correct isolation devices: line protecting cut-outs, fuses (screw type fuses removed from the holder), earth leakage trips and contactors.
- The electrical installation must have an isolation device which lets you disconnect the appliance from the mains at all poles. The isolation device must have a contact opening width of minimum 3 mm.
- This appliance is supplied without a main plug and a main cable.

2.3 Use



WARNING!

Risk of injury, burns and electric shock or explosion.

- Do not change the specification of this appliance.
- Make sure that the ventilation openings are not blocked.
- Do not let the appliance stay unattended during operation.
- Deactivate the appliance after each use.
- Be careful when you open the appliance door while the appliance is in operation. Hot air can release.
- Do not operate the appliance with wet hands or when it has contact with water.
- Do not apply pressure on the open door.
- Do not use the appliance as a work surface or as a storage surface.
- Open the appliance door carefully. The use of ingredients with alcohol can cause a mixture of alcohol and air.
- Do not let sparks or open flames to come in contact with the appliance when you open the door.
- Do not put flammable products or items that are wet with flammable products in, near or on the appliance.



WARNING!

Risk of damage to the appliance.

- To prevent damage or discoloration to the enamel:
 - do not put ovenware or other objects in the appliance directly on the bottom.
 - do not put aluminium foil directly on the bottom of cavity of the appliance.
 - do not put water directly into the hot appliance.
 - do not keep moist dishes and food in the appliance after you finish the cooking.
 - be careful when you remove or install the accessories.
- Discoloration of the enamel or stainless steel has no effect on the performance of the appliance.
- Use a deep pan for moist cakes. Fruit juices cause stains that can be permanent.
- Always cook with the appliance door closed.

2.4 Care and cleaning



WARNING!

Risk of injury, fire, or damage to the appliance.

- Before maintenance, deactivate the appliance and disconnect the mains plug from the mains socket.
- Make sure the appliance is cold. There is the risk that the glass panels can break.

SAFETY INSTRUCTIONS

- Replace immediately the door glass panels when they are damaged. Contact the Authorised Service Centre.
- Be careful when you remove the door from the appliance. The door is heavy!
- Clean regularly the appliance to prevent the deterioration of the surface material.
- Clean the appliance with a moist soft cloth. Use only neutral detergents. Do not use abrasive products, abrasive cleaning pads, solvents or metal objects.
- If you use an oven spray, follow the safety instructions on its packaging.

2.5 Internal lighting

**WARNING!**

Risk of electric shock.

- Concerning the lamp(s) inside this product and spare part lamps sold separately: These lamps are intended to withstand extreme physical conditions in household appliances, such as temperature, vibration, humidity, or are intended to signal information about the operational status of the appliance. They are not intended to be used in other applications and are not suitable for household room illumination.
- This product contains a light source of energy efficiency class G.
- Use only lamps with the same specifications.

2.6 Service

- To repair the appliance contact the Authorised Service Centre.
- Use original spare parts only.

2.7 Disposal

**WARNING!**

Risk of injury or suffocation.

- Contact your municipal authority for information on how to dispose of the appliance.
- Disconnect the appliance from the mains supply.
- Cut off the mains electrical cable close to the appliance and dispose of it.
- Remove the door catch to prevent children or pets from becoming trapped in the appliance.

3. PRODUCT DESCRIPTION

3.1 General overview

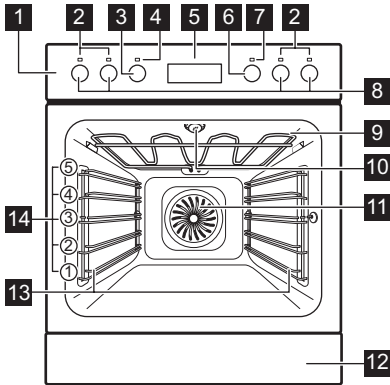

- 1** Control panel
- 2** Lamps / symbols of the cooking zones
- 3** Knob for the heating functions
- 4** Power lamp / symbol
- 5** Display
- 6** Control knob
- 7** Temperature indicator / symbol
- 8** Knobs for the cooking zones
- 9** Heating element
- 10** Lamp
- 11** Fan
- 12** Drawer
- 13** Shelf support, removable
- 14** Shelf positions

3.2 Accessories

Wire shelf

For cookware, cake tins, roasts.

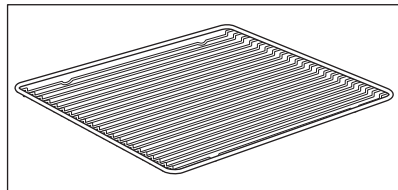

CONTROL PANEL

Baking tray

For cakes and biscuits.

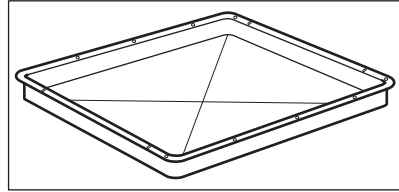

4. CONTROL PANEL

4.1 Retractable knobs

To use the appliance press the knob. The knob comes out.

4.2 Knobs for the cooking zones





WARNING!

Refer to Safety chapters in the hob user manual.

You can operate the hob with the knobs for the cooking zones.

4.3 Heat settings

Knob indication	Function
0	Off position
	Keep warm setting
1 - 9	Heat settings
	Double zone switch

Turn the knob to set a heat setting.







4.4 Using the double zone (if applicable)



To activate the double zone, turn the knob clockwise. Do not turn it through the stop position.

1. Turn the knob clockwise to position 9.
2. Turn the knob slowly to the symbol  until you can hear a click. The two cooking zones are on.
3. To set the necessary heat setting refer to "Heat settings".







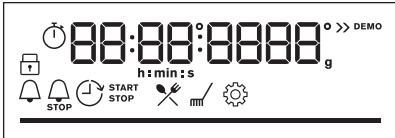

4.5 Control panel sensor fields

				OK		
Timer	Fast Heat Up	Light	Lock	Confirm setting	Press	Turn the knob

Select a heating function to turn on the oven.

Turn the knob for the heating functions to the off position to turn the oven off.

	Display with key functions.
---	-----------------------------

Display indicators:	 Lock	 Assisted Cooking	 Settings	 Fast Heat Up
Timer indicators:		 STOP		
Progress bar - for temperature or time. The bar is fully red when the oven reaches the set temperature.				

5. BEFORE FIRST USE







WARNING!





Refer to Safety chapters.

DAILY USE

5.1 Initial cleaning

Before first use clean the empty oven and set the time:			
			 00:00 Set the time. Press OK .



5.2 Initial preheating

 Preheat the empty oven before the first use.	
Step 1	Remove all accessories and removable shelf supports from the oven.
Step 2	Set the maximum temperature for the function:  Let the oven operate for 1 h.
Step 3	Set the maximum temperature for the function:  Let the oven operate for 15 min.
 The oven can emit an odour and smoke during preheating. Make sure that the room is ventilated.	

6. DAILY USE

 WARNING! Refer to Safety chapters.









6.1 How to set: Heating functions



Step 1	Step 2
 	 °C
Select a heating function.	Set the temperature. Press OK .

 - press and hold to turn on the function: Fast Heat Up. It is available for some oven functions.

6.2 Heating functions

Standard heating functions

Heating function	Application
 <p>True Fan Cooking</p>	To bake on up to three shelf positions at the same time and to dry food. Set the temperature 20 - 40 °C lower than for Conventional Cooking.
 <p>Conventional Cooking</p>	To bake and roast food on one shelf position.
 <p>Frozen Foods</p>	To make convenience food (e.g., french fries, potato wedges or spring rolls) crispy.
 <p>Pizza Function</p>	To bake pizza. To make intensive browning and a crispy bottom.
 <p>Bottom Heat</p>	To bake cakes with crispy bottom and to preserve food.
 <p>Defrost</p>	To defrost food (vegetables and fruit). The defrosting time depends on the amount and size of the frozen food.
 <p>Moist Fan Baking</p>	This function is designed to save energy during cooking. When you use this function, the temperature in the cavity may differ from the set temperature. The residual heat is used. The heating power may be reduced. For more information refer to "Daily Use" chapter, Notes on: Moist Fan Baking.
 <p>Grill</p>	To grill thin pieces of food and to toast bread.

Heating function	Application
 Turbo Grilling	To roast large meat joints or poultry with bones on one shelf position. To make gratins and to brown.
 Menu	To enter the Menu: Assisted Cooking, Cleaning, Settings.

6.3 Notes on: Moist Fan Baking

This function was used to comply with the energy efficiency class and ecodesign requirements (according to EU 65/2014 and EU 66/2014). Tests according to: IEC/EN 60350-1

The oven door should be closed during cooking so that the function is not interrupted and the oven operates with the highest energy efficiency possible.







When you use this function the lamp automatically turns off after 30 sec.

For the cooking instructions refer to "Hints and tips" chapter, Moist Fan Baking. For general energy saving recommendations refer to "Energy Efficiency" chapter, Energy Saving.

6.4 How to set: Assisted Cooking



Every dish in this submenu has a recommended function and temperature. You can adjust the time and the temperature during cooking.

For some of the dishes you can also cook with:	<ul style="list-style-type: none"> • Weight Automatic
--	--







Assisted Cooking - use it to prepare a dish quickly with default settings:			
Step 1	Step 2	Step 3	Step 4
 	 	 P1 - P45	 OK
Enter the menu.	Select Assisted Cooking. Press OK .	Select the dish. Press OK .	Insert the dish to the oven. Confirm setting.

6.5 Assisted Cooking













Legend	
	Weight Automatic available.













Legend	
	Preheat the oven before you start cooking.
	Shelf level.





















When the function ends check if the food is ready.















	Dish	Weight	Shelf level / Accessory	Duration time
Beef 				
P1	Roast Beef, rare	1 - 1,5 kg; 4 - 5 cm thick pieces	 2; baking tray Fry the meat for a few minutes on a hot pan. Insert to the oven.	40 min
P2	Roast Beef, medium			50 min
P3	Roast Beef, well done			60 min
P4	Steak, medium	180 - 220 g per piece; 3 cm thick slices	  3; roasting dish on wire shelf Fry the meat for a few minutes on a hot pan. Insert to the oven.	15 min
P5	Beef roast / braised (prime rib, top round, thick flank)	1,5 - 2 kg	  2; roasting dish on wire shelf Fry the meat for a few minutes on a hot pan. Add liquid. Insert to the oven.	120 min
P6	Roast Beef, rare (slow cooking)	1 - 1,5 kg; 4 - 5 cm thick pieces	 2; baking tray Use your favourite spices or simply salt and fresh grounded pepper. Fry the meat for a few minutes on a hot pan. Insert to the oven.	75 min
P7	Roast Beef, medium (slow cooking)			85 min
P8	Roast Beef, well done (slow cooking)			130 min

DAILY USE

	Dish	Weight	Shelf level / Accessory	Duration time
P9	Fillet, rare (slow cooking)	0,5 - 1,5 kg; 5 - 6 cm thick pieces	 2; baking tray Use your favourite spices or simply salt and fresh grounded pepper. Fry the meat for a few minutes on a hot pan. Insert to the oven.	75 min
P10	Fillet, medium (slow cooking)			90 min
P11	Fillet, done (slow cooking)			120 min
Veal 				
P12	Veal roast (e.g. shoulder)	0,8 - 1,5 kg; 4 cm thick pieces	  2; roasting dish on wire shelf Use your favourite spices. Add liquid. Roast covered.	80 min
Pork 				
P13	Pork roast neck or shoulder	1,5 - 2 kg	  2; roasting dish on wire shelf Turn the meat after half of the cooking time.	120 min
P14	Pulled pork (slow cooking)	1,5 - 2 kg	 2; baking tray Use your favourite spices. Turn the meat after half of the cooking time to get an even browning.	215 min
P15	Loin, fresh	1 - 1,5 kg; 5 - 6 cm thick pieces	 2; roasting dish on wire shelf Use your favourite spices.	55 min
P16	Spare Ribs	2 - 3 kg; use raw, 2 - 3 cm thin spare ribs	 3; deep pan Add liquid to cover the bottom of a dish. Turn the meat after half of the cooking time.	90 min
Lamb 				
P17	Lamb leg with bones	1,5 - 2 kg; 7 - 9 cm thick pieces	 2; roasting dish on baking tray Add liquid. Turn the meat after half of the cooking time.	130 min

	Dish	Weight	Shelf level / Accessory	Duration time
Poultry 🐔				
P18	Whole chicken	1 - 1,5 kg; fresh	  2; casserole dish on baking tray Use your favourite spices. Turn the chicken after half of the cooking time to get an even browning.	60 min
P19	Half chicken	0,5 - 0,8 kg	 3; baking tray Use your favourite spices.	40 min
P20	Chicken breast	180 - 200 g per piece	  2; casserole dish on wire shelf Use your favourite spices. Fry the meat for a few minutes on a hot pan.	25 min
P21	Chicken legs, fresh	-	 3; baking tray If you marinated chicken legs first, set lower temperature and cook them longer.	30 min
P22	Duck, whole	2 - 3 kg	  2; roasting dish on wire shelf Use your favourite spices. Put the meat on roasting dish. Turn the duck after half of the cooking time.	100 min
P23	Goose, whole	4 - 5 kg	  2; deep pan Use your favourite spices. Put the meat on deep baking tray. Turn the goose after half of the cooking time.	110 min
Other 🍖				
P24	Meat loaf	1 kg	 2; wire shelf Use your favourite spices.	60 min
Fish 🐟				
P25	Whole fish, grilled	0,5 - 1 kg per fish	 2; baking tray Fill the fish with butter and use your favourite spices and herbs.	30 min

	Dish	Weight	Shelf level / Accessory	Duration time
P26	Fish fillet	-	  3; casserole dish on wire shelf Use your favourite spices.	20 min
Sweet baking / desserts   				
P27	Cheesecake	-	 2;  28 cm springform tin on wire shelf	90 min
P28	Apple cake	-	 3; baking tray	45 min
P29	Apple tart	-	 2; pie form on wire shelf	40 min
P30	Apple pie	-	 1;  22 cm pie form on wire shelf	60 min
P31	Brownies	2 kg	 3; deep pan	30 min
P32	Chocolate muffins	-	 3; muffin tray on wire shelf	25 min
P33	Loaf cake	-	 2; loaf pan on wire shelf	50 min
Vegetable / Side dishes   				
P34	Baked potatoes	1 kg	 2; baking tray Put the whole potatoes with skin on baking tray.	50 min
P35	Wedges	1 kg	 3; baking tray lined with baking paper Use your favourite spices. Cut potatoes into pieces.	35 min
P36	Grilled mixed vegetables	1 - 1,5 kg	 3; baking tray lined with baking paper Use your favourite spices. Cut the vegetables into pieces.	30 min
P37	Croquets, frozen	0,5 kg	 3; baking tray	25 min



	Dish	Weight	Shelf level / Accessory	Duration time
P38	Pommes, frozen	0,75 kg	 3; baking tray	25 min
Gratins, bread and pizza   				
P39	Meat / vegetable lasagna with dry noodle plates	1 - 1,5 kg	 2; casserole dish on wire shelf	45 min
P40	Potato gratin (raw potatoes)	1 - 1,5 kg	 1; casserole dish on wire shelf Rotate the dish after half of the cooking time.	50 min
P41	Pizza fresh, thin	-	  2; baking tray lined with baking paper	15 min
P42	Pizza fresh, thick	-	  2; baking tray lined with baking paper	25 min
P43	Quiche	-	 2; baking tin on wire shelf	45 min
P44	Baguette / Ciabatta / White bread	0,8 kg	  3; baking tray lined with baking paper More time needed for white bread.	30 min
P45	All grain / rye / dark bread all grain in loaf pan	1 kg	  2; baking tray lined with baking paper / wire shelf	60 min

7. CLOCK FUNCTIONS



7.1 Clock functions







Clock Function	Application
	Minute minder. When the timer ends, the signal sounds.

CLOCK FUNCTIONS







Clock Function	Application
	Cooking time. When the timer ends, the signal sounds and the heating function stops.
	Time Delay. To postpone the start and / or end of cooking.
	Uptimer. Maximum is 23 h 59 min. This function has no effect on the operation of the oven. To turn on and off the Uptimer select: Menu, Settings.











7.2 How to set: Clock functions

How to set: Time of day		
Step 1	Step 2	Step 3
		
To change the time of day enter the menu and select Settings, Time of day.	Set the clock.	Press: OK.

How to set: Minute minder			
Step 1	The display shows: 0:00 	Step 2	Step 3
			
Press: 		Set the Minute minder	Press: OK.
 Timer starts counting down immediately.			

HOW TO USE: ACCESSORIES

How to set: Cooking time					
Step 1	Step 2	The display shows: 0:00  STOP	Step 3	Step 4	
					
Choose a heating function and set the temperature.	Press repeatedly: 			Set the cooking time.	Press: OK.
 Timer starts counting down immediately.					

How to set: Time Delay									
Step 1	Step 2	The display shows: the time of day  START	Step 3	Step 4	The display shows: --:--  STOP	Step 5	Step 6		
									
Select the heating function.	Press repeatedly: 			Set the start time.		Press: OK.		Set the end time.	Press: OK.
 Timer starts counting down at a set start time.									

8. HOW TO USE: ACCESSORIES

8.1 Inserting accessories



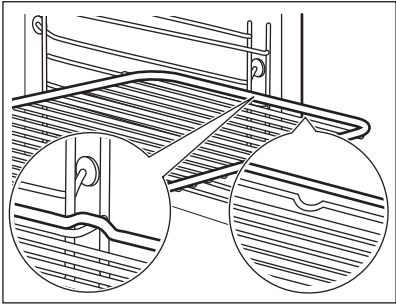
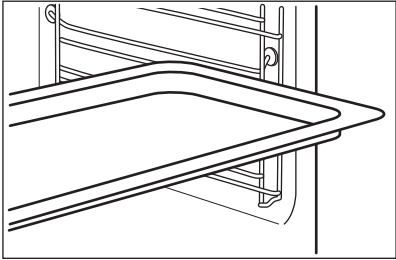

A small indentation at the top increases safety. The indentations are also anti-tip devices. The high rim around the shelf prevents cookware from slipping of the shelf.

ADDITIONAL FUNCTIONS

<p>Wire shelf: Push the shelf between the guide bars of the shelf support.</p>	
<p>Baking tray: Push the tray between the guide bars of the shelf support.</p>	



9. ADDITIONAL FUNCTIONS

9.1 Lock

<p>This function prevents an accidental change of the appliance function.</p>		
<p>Turn it on when the appliance works - the set cooking continues, the control panel is locked. Turn it on when the appliance is off - it cannot be turned on, the control panel is locked.</p>		
	<p> - press and hold to turn on the function. A signal sounds.</p>	<p> - press and hold to turn it off.</p>
<p> 3 x  - flashes when the lock is turned on.</p>		

9.2 Automatic switch-off

For safety reasons the oven turns off after some time, if a heating function works and you do not change any settings.

 (°C)	 (h)
30 - 115	12.5
120 - 195	8.5
200 - 245	5.5
250 - maximum	3

The Automatic switch-off does not work with the functions: Light, Time Delay.



9.3 Cooling fan

When the appliance operates, the cooling fan turns on automatically to keep the surfaces of the appliance cool. If you turn off the appliance, the cooling fan can continue to operate until the appliance cools down.



10. HINTS AND TIPS

10.1 Moist Fan Baking

For the best results follow suggestions listed in the table below.
Use the third shelf position.



	 (°C)	 (min)
Pasta gratin	200 - 220	45 - 55
Potato gratin	180 - 200	70 - 85
Moussaka	170 - 190	70 - 95
Lasagne	180 - 200	75 - 90
Cannelloni	180 - 200	70 - 85
Bread pudding	190 - 200	55 - 70
Rice pudding	170 - 190	45 - 60
Apple cake, made of sponge cake mixture (round cake tin)	160 - 170	70 - 80

HINTS AND TIPS

	 (°C)	 (min)
White bread	190 - 200	55 - 70

10.2 Moist Fan Baking - recommended accessories

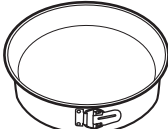





Use the dark and non-reflective tins and containers. They have better heat absorption than the light colour and reflective dishes.

			
Pizza pan	Baking dish	Ramekins	Flan base tin
Dark, non-reflective 28 cm diameter	Dark, non-reflective 26 cm diameter	Ceramic 8 cm diameter, 5 cm height	Dark, non-reflective 28 cm diameter

10.3 Cooking tables for test institutes

Information for test institutes

Tests according to: EN 60350, IEC 60350.





 BAKING ON ONE LEVEL. Baking in tins				
		 (°C)	 (min)	
Fatless sponge cake	True Fan Cooking	140 - 150	35 - 50	2
Fatless sponge cake	Conventional Cooking	160	35 - 50	2
Apple pie, 2 tins Ø20 cm	True Fan Cooking	160	60 - 90	2
Apple pie, 2 tins Ø20 cm	Conventional Cooking	180	70 - 90	1



BAKING ON ONE LEVEL. Biscuits







Use the third shelf position.

		 (°C)	 (min)
Short bread / Pastry strips	True Fan Cooking	140	25 - 40
Short bread / Pastry strips, preheat the empty oven	Conventional Cooking	160	20 - 30
Small cakes, 20 per tray, preheat the empty oven	True Fan Cooking	150	20 - 35
Small cakes, 20 per tray, preheat the empty oven	Conventional Cooking	170	20 - 30



MULTILEVEL BAKING. Biscuits

		 (°C)	 (min)	
Short bread / Pastry strips	True Fan Cooking	140	25 - 45	1 / 4
Small cakes, 20 per tray, preheat the empty oven	True Fan Cooking	150	23 - 40	1 / 4
Fatless sponge cake	True Fan Cooking	160	35 - 50	1 / 4

CARE AND CLEANING



Preheat the empty oven for 5 minutes.



Grill with the maximum temperature setting.



(min)



Toast

Grill

1 - 3

5

Beef steak, turn halfway through

Grill

24 - 30

4

11. CARE AND CLEANING



WARNING!

Refer to Safety chapters.

11.1 Notes on cleaning



Cleaning Agents

Clean the front of the appliance only with a microfibre cloth with warm water and a mild detergent.

Use a cleaning solution to clean metal surfaces.

Clean stains with a mild detergent.



Everyday Use

Clean the cavity after each use. Fat accumulation or other residue may cause fire.

Do not store the food in the appliance for longer than 20 minutes. Dry the cavity only with a microfibre cloth after each use.

 Accessories	<p>Clean all accessories after each use and let them dry. Use only a microfibre cloth with warm water and a mild detergent. Do not clean the accessories in a dishwasher.</p>
	<p>Do not clean the non-stick accessories using abrasive cleaner or sharp-edged objects.</p>

11.2 How to remove: Shelf supports

Remove the shelf supports to clean the oven.

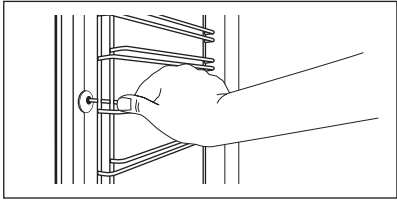
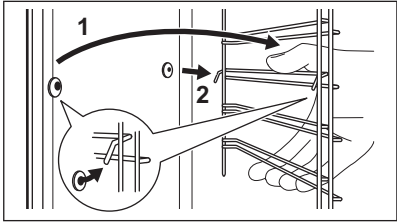
Step 1	Turn off the oven and wait until it is cold.	
Step 2	Pull the front of the shelf support away from the side wall.	
Step 3	Pull the rear end of the shelf support away from the side wall and remove it.	
Step 4	Install the shelf supports in the opposite sequence.	

11.3 How to remove: Grill

	<p>WARNING! There is a risk of burns.</p>
--	--

CARE AND CLEANING

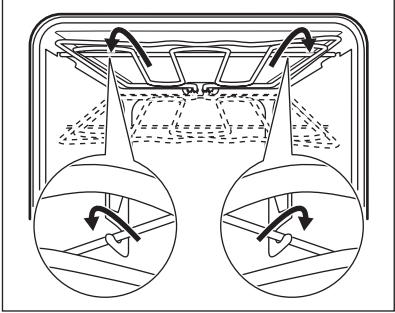
Step 1	Turn off the oven and wait until it is cold to clean it. Remove the shelf supports.	
Step 2	Grab the grill corners. Pull it forwards against the spring pressure and out of two holders. The grill folds down.	
Step 3	Clean the oven ceiling with warm water, a soft cloth and a mild detergent. Let it dry.	
Step 4	Install the grill in the opposite sequence.	
Step 5	Install the shelf supports.	

11.4 How to remove and install: Door

You can remove the door and the internal glass panels to clean it. The number of glass panels is different for different models.



WARNING!

The door is heavy.



CAUTION!

Carefully handle the glass, especially around the edges of the front panel. The glass can break.

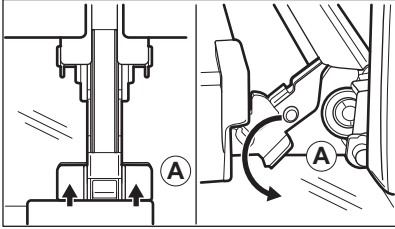
Step 1	Fully open the door.	
Step 2	Lift and press the clamping levers (A) on the two door hinges.	
Step 3	Close the oven door to the first opening position (approximately 70° angle). Hold the door at both sides and pull it away from the oven at an upwards angle. Put the door with the outer side down on a soft cloth on a stable surface.	

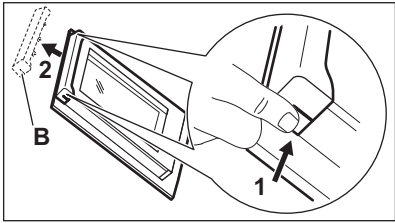
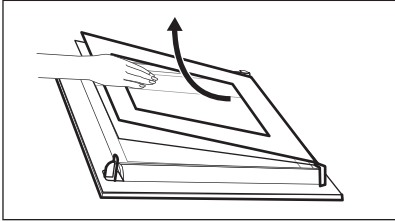
<p>Step 4</p>	<p>Hold the door trim (B) on the top edge of the door at the two sides and push inwards to release the clip seal.</p>	
<p>Step 5</p>	<p>Pull the door trim to the front to remove it.</p>	
<p>Step 6</p>	<p>Hold the door glass panels on their top edge one by one and pull them up out of the guide.</p>	
<p>Step 7</p>	<p>Clean the glass panel with water and soap. Dry the glass panel carefully. Do not clean the glass panels in the dishwasher.</p>	
<p>Step 8</p>	<p>After cleaning, do the above steps in the opposite sequence.</p>	
<p>Step 9</p>	<p>Install the smaller panel first, then the larger and the door. Make sure that the glasses are inserted in the correct position otherwise the surface of the door may overheat.</p>	

11.5 How to replace: Lamp



WARNING!

Risk of electric shock.
The lamp can be hot.

Before you replace the lamp:

Step 1	Step 2	Step 3
<p>Turn off the oven. Wait until the oven is cold.</p>	<p>Disconnect the oven from the mains.</p>	<p>Put a cloth on the bottom of the cavity.</p>

TROUBLESHOOTING

Top lamp

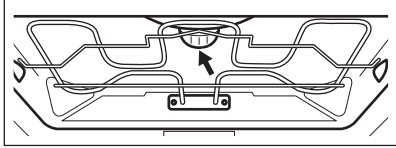
Step 1	Turn the glass cover to remove it.	
Step 2	Clean the glass cover.	
Step 3	Replace the lamp with a halogen, 230 V, 40 W, 300 °C heat-resistant lamp.	
Step 4	Install the glass cover.	

12. TROUBLESHOOTING



WARNING!

Refer to Safety chapters.

12.1 What to do if...

In any cases not included in this table please contact with an Authorised Service Centre.



The oven does not turn on or does not heat up

Problem	Check if...
You cannot activate or operate the oven.	The oven is correctly connected to an electrical supply.
The oven does not heat up.	The automatic switch-off is deactivated.
The oven does not heat up.	The fuse is not blown.
The oven does not heat up.	The Lock is off.



Components

Problem	Check if...
The lamp is turned off.	Moist Fan Baking - is turned on.

 Components	
The lamp does not work.	The lamp is burnt out.

 Error codes	
The display shows...	Check if...
00:00	There was a power cut. Set the time of day.
If the display shows an error code that is not in this table turn the house fuse off and on to restart the oven. If the error code recurs contact an Authorised Service Centre.	

12.2 Service data

If you cannot find a solution to the problem yourself, contact your dealer or an Authorised Service Centre.

The necessary data for the service centre is on the rating plate. The rating plate is on the front frame of the appliance cavity. Do not remove the rating plate from the appliance cavity.

We recommend that you write the data here:	
Model (MOD.)
Product number (PNC)
Serial number (S.N.)

13. ENERGY EFFICIENCY

13.1 Product Information and Product Information Sheet

Supplier's name	Electrolux
Model identification	EH7L4CN 948533595 EH7L4SW 948533596 EH7L4WE 948533597
Energy Efficiency Index	81.2

ENERGY EFFICIENCY

Energy efficiency class	A+	
Energy consumption with a standard load, conventional mode	1.09 kWh/cycle	
Energy consumption with a standard load, fan-forced mode	0.69 kWh/cycle	
Number of cavities	1	
Heat source	Electricity	
Volume	71 l	
Type of oven	Built-Under Oven	
Mass	EH7L4CN	39.0 kg
	EH7L4SW	39.0 kg
	EH7L4WE	39.0 kg

IEC/EN 60350-1 - Household electric cooking appliances - Part 1: Ranges, ovens, steam ovens and grills - Methods for measuring performance.

13.2 Energy saving



The appliance has features which help you save energy during everyday cooking.

Make sure that the appliance door is closed when the appliance operates. Do not open the appliance door too often during cooking. Keep the door gasket clean and make sure it is well fixed in its position.

Use metal cookware to improve energy saving.

When possible, do not preheat the appliance before cooking.

Keep breaks between baking as short as possible when you prepare a few dishes at one time.

Cooking with fan

When possible, use the cooking functions with fan to save energy.

Residual heat

The fan and lamp continue to operate. When you turn off the appliance, the display shows the residual heat. You can use that heat to keep the food warm.

When the cooking duration is longer than 30 min, reduce the appliance temperature to minimum 3 - 10 min before the end of cooking. The residual heat inside the appliance will continue to cook.

Use the residual heat to warm up other dishes.

Keep food warm

Choose the lowest possible temperature setting to use residual heat and keep a meal warm.

The residual heat indicator or temperature appears on the display.

Cooking with the lamp off

Turn off the lamp during cooking. Turn it on only when you need it.



Moist Fan Baking



Function designed to save energy during cooking.







When you use this function the lamp automatically turns off after 30 sec. You may turn on the lamp again but this action will reduce the expected energy savings.

14. MENU STRUCTURE

14.1 Menu

	 - select to enter the Menu.
---	---

Menu structure	
Assisted Cooking 	Settings 

Step 1	Step 2	Step 3	Step 4	Step 5
 	 OK	 O1 - 10	 OK	
Select the Menu, Settings.	Confirm setting.	Select the setting.	Confirm setting.	Adjust the value and press OK.

Settings					
O1	Time of day	Change	O2	Display brightness	1 - 5
O3	Key tones	1 - Beep 2 - Click 3 - Sound off	O4	Buzzer volume	1 - 4
O5	Uptimer	On / Off	O6	Light	On / Off
O7	Fast Heat Up	On / Off	O8	Demo mode	Activation code: 2468
O9	Software version	Check	O10	Reset all settings	Yes / No

15. GUARANTEE

Customer Service Centres



Point of Service		
Industriestrasse 10 5506 Mägenwil	Le Trési 6 1028 Prévèrenge	Via Violino 11 6928 Manno
Morgenstrasse 131 3018 Bern		
Langgasse 10 9008 St. Gallen		
Am Mattenhof 4a/b 6010 Kriens		
Schlossstrasse 1 4133 Pratteln		
Comercialstrasse 19 7000 Chur		

Spare parts service Industriestrasse 10, 5506 Mägenwil, Tel. 0848 848 111

Specialist advice/Sale Badenerstrasse 587, 8048 Zürich, Tel. 044 405 81 11

Warranty For each product we provide a two-year guarantee from the date of purchase or delivery to the consumer (with a guarantee certificate, invoice or sales receipt serving as proof). The guarantee covers the costs of materials, labour and travel. The guarantee will lapse if the operating instructions and conditions of use are not adhered to, if the product is incorrectly installed, or in the event of damage caused by external influences, force majeure, intervention by third parties or the use of non-genuine components.

16. ENVIRONMENTAL CONCERNS

Recycle materials with the symbol . Put the packaging in relevant containers to recycle it. Help protect the environment and human health by recycling waste of electrical and electronic appliances. Do not dispose of appliances marked with the symbol  with the household waste. Return the product to your local recycling facility or contact your municipal office.



For Switzerland:

Where should you take your old equipment?

Anywhere that sells new equipment or hand it in to official SENS collection points or official SENS recycling firms.

The list of official SENS collection points can be found at www.erecycling.ch

www.electrolux.com/shop



867371804-B-422022

